

Operator's Manual



RR211, RR270, RR300, RR390 PRO Rack Conveyor Washers



INSTRUCTION MANUAL FOR DISHWASHERS



It is important to keep this instruction manual near the appliance for future consultation.
If the appliance is sold or transferred to another user, make sure this manual remains with the appliance so that the new owner is informed about the warnings and operation of the appliance. These instructions are given for safety reasons and they must be read carefully before installing or using the appliance.

GENERAL INSTRUCTIONS

- The appliance must be connected to water and electrical supplies by qualified tradespersons only and according to local regulations.
- The appliance must be used by adults only. Do not let children play with, or operate this machine.
- Only persons trained to use this dishwasher are permitted to operate it.
- This appliance has been designed to wash food preparation and eating utensils. It has NOT been designed to wash objects soiled with petrol, paint, remnants of steel or iron, corrosive chemical products such as acids, alkalis, or solvents or any item that cannot be immersed in water.
- Do not open the appliance door(s) while the appliance is operating. The appliance has a safety device which stops operation if a door is accidentally opened.
- After using the appliance, isolate the electric and water supply.
- Do not attempt to repair the appliance. Repairs made by unqualified persons may cause further damage and will void warranty.
- Repairs and servicing of this appliance must be carried out by Rhima personnel only.

IMPORTANT CUSTOMER INFORMATION

- To request a service, detergents or rinse additive contact your local Rhima Service centre below:

Australia: **1300 347 944**

New Zealand: **0800 902 054**

Singapore: **+65 9107 8943**

ELECTRICAL INSTALLATION

This appliance must be connected to an earthed 3-phase electrical switched outlet of an appropriate rating.

PLUMBING INSTALLATION

The Australian installation shall be in accordance with The Plumbing Code of Australia (PCA).

This appliance should be connected to a hot water supply (Max 65°C) for in accordance with Australian Standard AS/NZS 3500.1. for optimum performance.

The water supply pressure should be a minimum 200 kPa at all times and flow rate should be at least 15 litres per minute. A static pressure higher than 600 kPa (73.5 psi) requires a pressure reducing valve upstream of the supply line. If water pressure is below 200 kPa, the use of a rinse booster pump is recommended.

This appliance is designed to drain to a tundish. Waste connection to a spigot is not recommended and may cause draining issues.

The drainpipe should withstand 70°C (158°F) in continuous duty conditions.

The grey water drain hose must have a fixed watertight seal above the tundish in accordance with the Australian Standard AS/NZS 3500.2.

A DIAGRAM SHOWING THE CORRECT METHOD OF WASTE INSTALLATION IN ACCORDANCE WITH THE AUSTRALIAN STANDARD AS/NZS 3500.2 IS BELOW

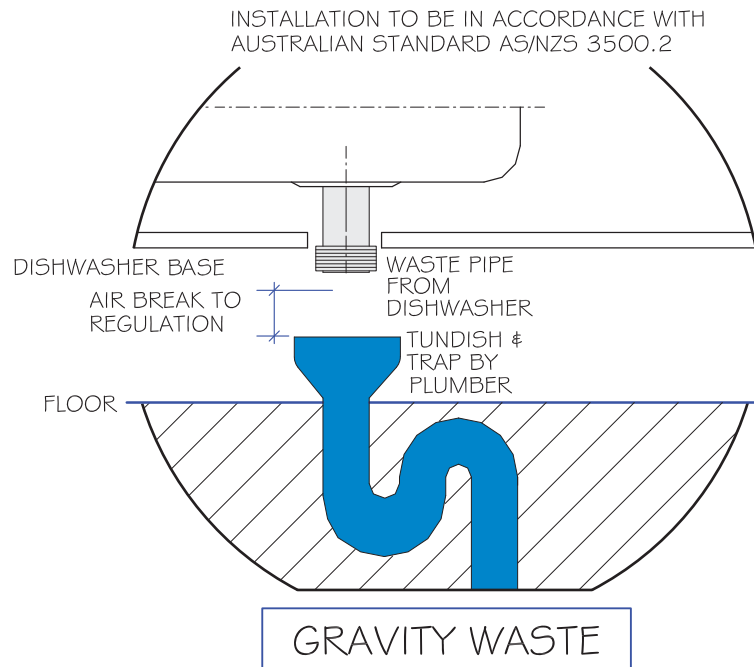

VENTILATION

Use extractor fans to guarantee a minimum ventilation of 500 m³/h. Increase the ventilation rate to 1500 m³/h if the machine is equipped with drying system. It is suggested to position the extractor fans close to the machine entry and exit and in correspondence to the heat recovery fans.

MACHINE DESCRIPTION

Description of the machine, its accessories and its guards

Machine description

Refer to annexes for the technical data of the machines.

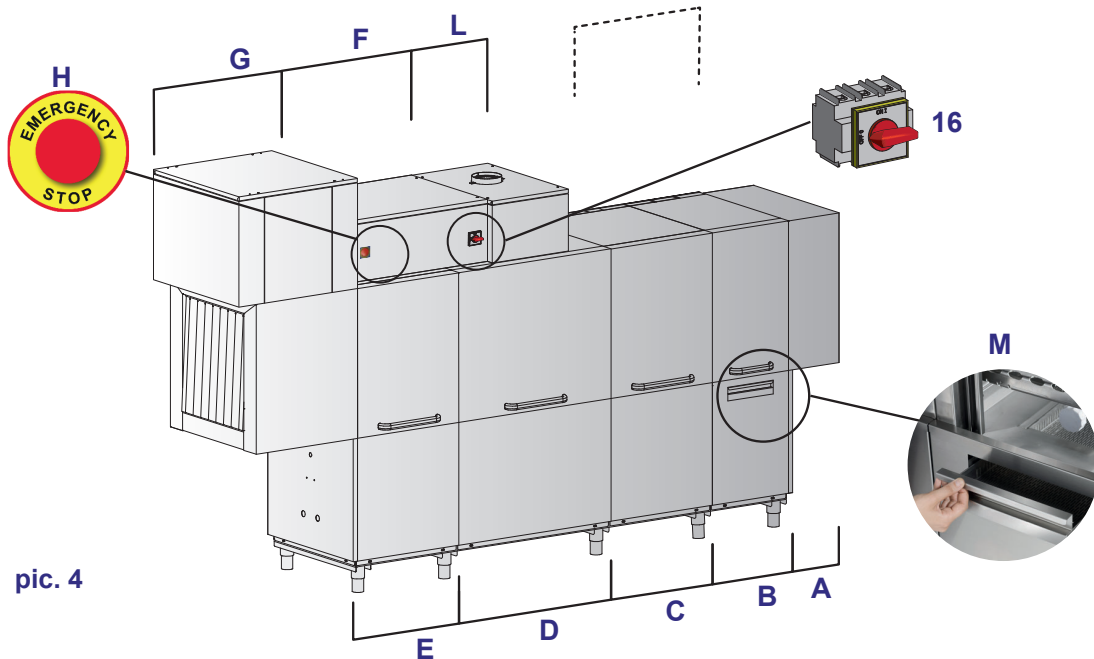

Example:

MACHINE IN RIGHT EXECUTION

A - SPLASH GUARD

B - AUTOMATIC SHOWER WITH DRAWER STRAINER

C - PRE-WASH

D - FIRST WASH

E - PRE-RINSE AND RINSE MODULE

F - CONTROL PANEL

G - DRYER

H - EMERGENCY BUTTON

L - HEAT RECOVERY/STEAM CONDENSER/HEAT RECOVERY WITH HEAT PUMP

M - DRAWER STRAINER

16 - CIRCUIT-BREAKER SWITCH

Module	Dimension		
	Width	Height	Depth
A - SPLASH GUARD	300 mm	1520 mm	900 mm
B - AUTOMATIC SHOWER WITH DRAWER STRAINER	450 mm		
C - PRE-WASH	600 mm or 900 mm		
D - WASH	900 mm		
E - PRE-RINSE AND RINSE MODULE	600 mm		
F - CONTROL PANEL	850 mm	1830 mm	
G - DRYER	600 mm (700 mm)	2070 mm	
L - HEAT RECOVERY/STEAM CONDENSER	450 mm or 1300 mm	1860 mm	
L - HEAT RECOVERY WITH HEAT PUMP (BIG)	1000 mm	2070 mm	
L - HEAT RECOVERY WITH HEAT PUMP (SMALL)	700 mm		

This machine is built with high quality materials in particular AISI 304 stainless steel (AISI 316 for boilers and tanks) and in high thickness to ensure a longer lifetime.

The machine is built in different sections:

Pre-wash module (the presence depends on the model chosen): a preliminary rough washing is carried out with low temperature thermostatically controlled to melt the alimentary residuals and avoid the proteins denaturation.

On machines with pre-wash, the initial tanks filling occurs in several phases:

- Phase 1: wash tanks only filling
- Phase 2: filling interruption. Water heating using the heating elements until a proper pre-wash temperature is reached (factory-set)
- Phase 3: resume and filling conclusion
- Phase 4: resume and heating conclusion.

Wash module(s): a proper washing of the crockery is performed with temperature thermostatically controlled.

Rinse module: a pre-rinse is performed that removes most of the detergent, then a final rinse is performed with high temperature thermostatically controlled.

Autotimer: the Autotimer function (activated by default) allows stopping the machine if it is in start-mode but not operating at the moment.

It can happen in these cases:

1. The machine is working in vain (it is in operation but it is not used).
2. The machine is in operation but a baskets accumulation exiting the machine causes the limit switch SQ1 to trip (F1).
3. The machine is in operation with the drawer **M** open.

In these cases, the timer set by default at 300 seconds trips. When the time is over the energetic saving mode turns on.

By inserting a basket, clearing the exit or closing the drawer the machine restarts automatically to operate.

Available options

Automatic shower with drawer strainer **B:**

Module with low temperature water thermostatically not controlled, with drawer strainer **M**.

The filter collects the food residuals and it can easily be removed and cleaned during the operation thanks to the drawer, without opening the doors and getting in touch with the washing solution.

If the drawer is extracted during the washing, the machine stops the conveyor, the rinse and the module pump to allow the filter cleaning.

The wash pumps keep working.

The machine restart the operation as the drawer is repositioned.

Make sure that during the operation the filter is clean and correctly positioned.

Dryer **G:**

It conveys hot and dry air that creates the ideal conditions for the rinse aid action.

Depending on his/her needs the operator can turn on or off the dryer module heating part using the dedicated key, during the work.

Heat recovery **L:**

The goal is the recovery of the steam heat exiting the machine that otherwise would be dispersed, and use it to pre-heat the water entering the boiler.

The machine must have a cold water supply for the rinse.

Heat recovery with heat pump **L:**

The goal is the recovery of the steam heat exiting the machine that otherwise would be dispersed, and use it to pre-heat the water entering the boiler.

It exploits a heat pump to further increase the water temperature entering the boiler.

The machine must have a cold water supply for the rinse.

WARNING: If this optional is present the **Autotimer** must be set to a minimum value of 300 seconds



WARNING: Heat Recovery system and Steam Condenser - installation (optional)

It is strictly forbidden to connect the machine's vent directly with the outdoor!

Cold weather conditions might seriously damage the Thermal Recovery system or the Steam Condenser.

Pressure Increase Pump:

It allows a proper machine operation when the feeding water pressure of the machine is lower than 200 kPa.

Self-cleaning:

The system allows carrying out an automatic internal machine cleaning and rinsing cycle, when it has finished operating. Specific sanitizing product can be used.

The self-cleaning can be carried out only if:

- The machine is in stand-by
- The doors are closed
- The tanks are empty.

The display shows the Self-cleaning screen.

During the cycle all the other functions are disabled. If there is no electrical supply the cycle will be restarted automatically to ensure a proper execution of the cycle.

Self- Cleaning pressure increase pump:

It allows a proper Self-cleaning operation when the feeding water pressure of the machine is lower than 200 kPa.

Inlet water temperature probe:

The option allows to show the inlet water temperature on display.

CONTROL PANEL AND RELATED SYMBOLS

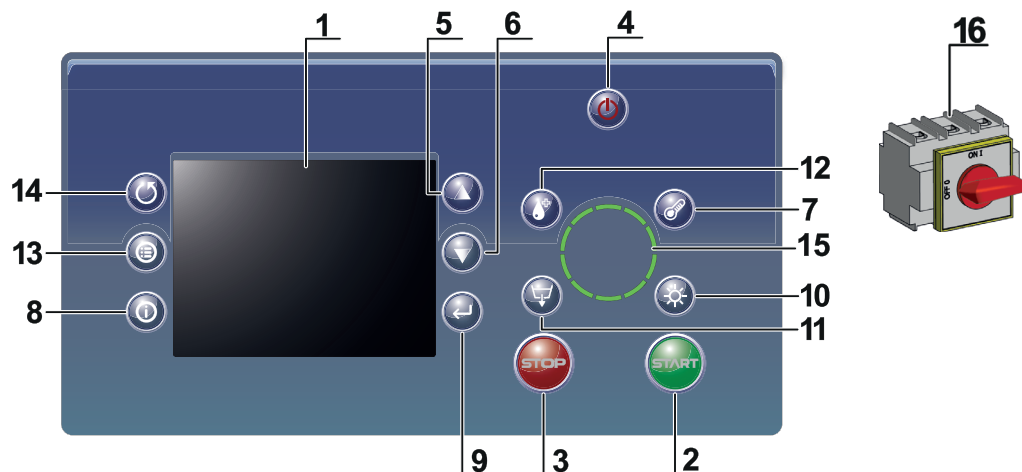

1: Display TFT back lit.

2: **START** key green backlit (not backlit: stand-by mode)

3: **STOP** key red backlit

4: **ON / OFF** key.

5 and 6: Scrolling keys (▼ / ▲, - / +).

7: **TEMPERATURES** key

8: **INFO** key.

9: **CONFIRMATION** key

10: **DRYER ON/OFF** key (optional).

11: Disabled

12: **SELF-CLEANING** key (optional).

13: **MENU** key

14: **RETURN** key

15: **SPEED** selector switch (from 1 to 5).

16: **CIRCUIT-BREAKER SWITCH**: position **0** = machine not powered - position **I** = machine powered.

Backlit keys only if it is possible to activate the corresponding function:

7: **TEMPERATURES** key. It allows the working temperature adjustment of the single modules.

8: **INFO** key. It provides additional information about the current status of the machine. In case of alarm it allows to have more details.

9: **CONFIRMATION** key.

10: **DRYER ON/OFF** key. It allows to enable or to disable the **DRYER** heatings. See paragraph **Available options** for more information.

MACHINE IN STAND-BY MODE

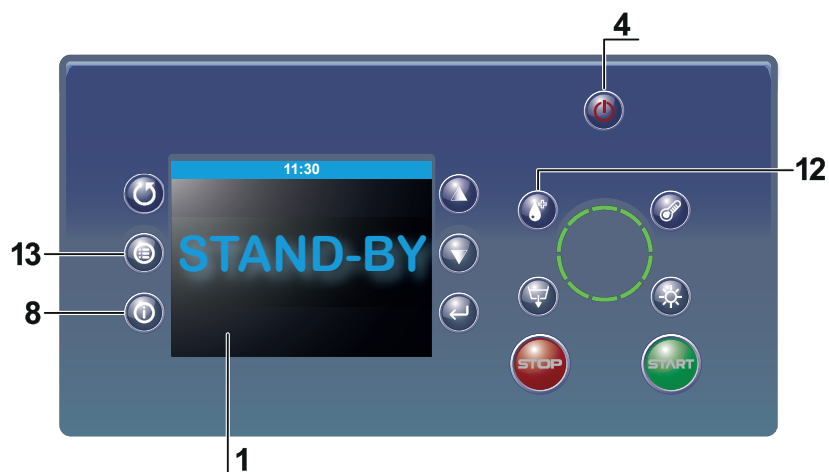

4: ON / OFF key with **ON** function. To turn the machine ON.

8: INFO key. Provides additional information about the current status of the machine.

12: SELF-CLEANING key. **Backlit key only when it is possible to activate SELF-CLEANING option.** If pressed the function is activated. See paragraph **Available options** for more information.

13: MENU key. Provides to access to menus and related work parameters.

MACHINE READY OR IN OPERATION

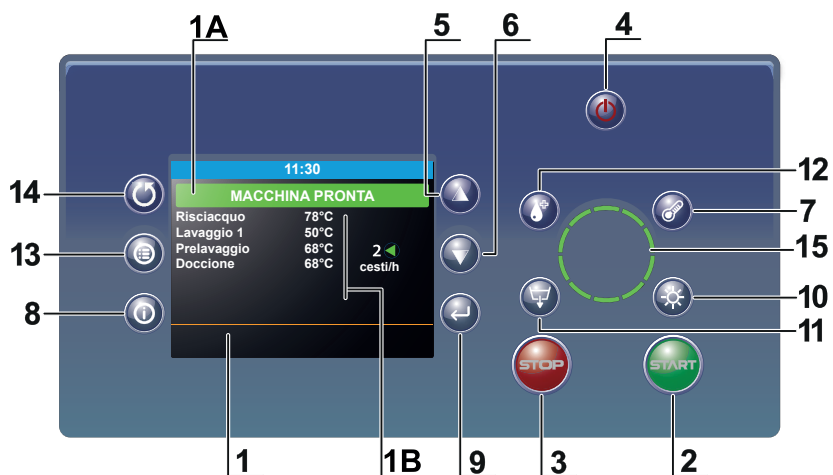

1: Notice area.

1A: Status of the machine.

1B: Measured temperatures for single modules.

2: START key back lit. When the machine is ready, it allows the start. The washing is activated by pressing this key.

3: STOP key back lit in red. When the machine is running, allows to stop and putting in ready mode. The conveyor is stopped by pressing this key.

4: ON / OFF key with **OFF** function. Allows putting the machine in **STAND-BY** mode.

5 and 6: Scrolling keys (**▼ / ▲, - / +**). When in the menu either scrolls the items or modifies all adjustable parameter (increase and/or decrease)

Backlit keys only if it is possible to activate the corresponding function:

7: TEMPERATURES key. Temperature quick adjustment. It allows the working temperature adjustment of the single modules.

8: INFO key. It provides additional information about the current status of the machine. In case of alarm it allows to have more details.

9: CONFIRMATION key.

10: DRYER ON/OFF key. It allows to enable or to disable the **DRYER** heatings. See paragraph **Available options** for more information.

FUNCTIONING OF THE MACHINE

Machine start-up

- Check that the over flow pipes are correctly inserted.
- Check if the surface filters are in their seats. Check that the washing and rinsing arms are properly inserted, as well as the curtains
Note: the long and narrow curtains are to be put at the entry and exit; the wide and short ones go inside the machine.
- Close the doors.
- Open the water valve(s).
- Position on **I** the circuit-breaker switch **16** (see chap. **CONTROL PANEL AND RELATED SYMBOLS**)
- Turn on the machine using the control panel.
- Wait for the filling and pre-heating operations to be completed. During the pre-heating the machine suspends the tanks filling. In this phase the display always shows the message **FILLING**.
Once filling of all the tanks is finished, the complete heating of the machine starts. In this phase the display shows the message **HEATING** and, by pressing the key **TEMPERATURE 7** (for about 10 seconds), it shows the reached temperatures. To ensure a proper washing, the start is not possible until the set temperatures are reached.
The several phases are represented on the display with specific icons.
- When the heating is finished, it is possible to proceed with the washing.

The working temperatures can be seen on the display.

Washing

To set the desired working speed, use the **SPEED** selector switch **15** turning it to the right or to the left to set a suitable speed for the type of work to be carried out. Confirm the selection by pressing key **9 CONFIRMATION** .

There are five possible settings:

- Speed 1: intensive wash.
- Speed from 2 to 3: dedicated to the washing of the average dirt.
- Speed from 4 to 5: dedicated to trays and dusting.
- If the machine is not equipped with an automatic chemicals dispenser, manually introduce the detergent in the wash tank. Carefully follow the instructions of the product manufacturer considering the water hardness (see chap. **DETERGENTS**).
- Press **START 2** button to start the conveyor movement.
- Carry out the cleaning off.
Place the baskets on the conveyor (see paragraph **Dishes and cutlery loading** - pic. 6 - 7).
Push the basket inside the splash guard **A** until the hooking with the towing system.
The washing sequence is the following:
 - ▶ Automatic shower (**B** - if there is the optional module) equipped with filter that can be periodically cleaned by extracting the drawer **M**.
 - ▶ Low temperature pre-wash (**C** - if there is).
 - ▶ Thermostatically controlled temperature wash **D**.
 - ▶ Pre-rinse **E**.
 - ▶ Final rinse **E** carried out with clean water coming from the hydric network and thermostatically controlled and eventually rinse aid.
 - ▶ Drying (**G** - if there is the optional module).
 - ▶ Baskets exit zone equipped with roller conveyor and limit switch.
- Push the **STOP 3** button to stop the operation.

N.B.: It is recommended to change the tank's water by new filling, when very dirty or, at least, twice a day.



WARNING: In case a dangerous situation occurs, push the emergency button **H**. The towing system and the absorptions turn off. Before restarting the appliance, check if the emergency is over. The emergency button rearmament does not start the machine but it position the appliance in stand-by. The emergency button does not have to be used as usual machine switch off system.



It is forbidden to remove the basket from the machine before it has come out of the tunnel and to insert hands or arms inside the machine when it is in movement (see pic. 5).

Note: Always turn the machine off before inserting your hands or arms inside the tunnel.

Note: Each model has the AUTOTIMER installed. If the machine does not wash objects for more than 5 minutes (the timing can be changed by the installer), the machine stops any optional installed (dryer, heat recovery, steam condenser, etc.) to cut down consumption.

Note: The machine is equipped with automatic economizers to cut consumption down, if the machine does not work continuously. If the objects to be washed are placed discontinuously, the wash pumps not involved are turned off.

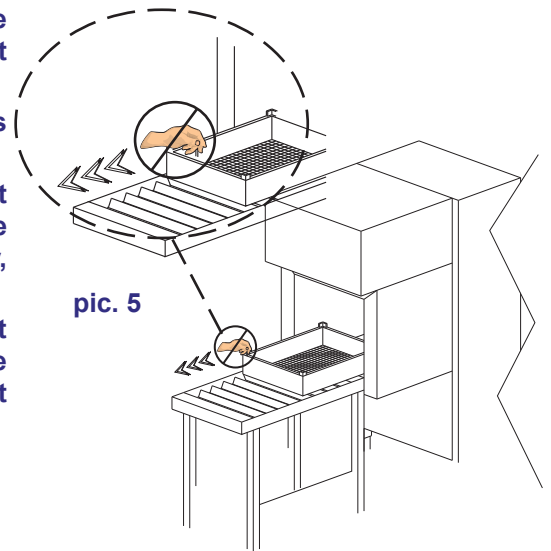

5.3 End washing operations

Press **STOP 3** key.

Press **ON / OFF 4** key.

Drain the tanks. Turn off the machine positioning on **0** the circuit-breaker switch **16**.

Shut the water supply valve(s).

Start the cleaning of the machine (see chap. **MAINTENANCE**).

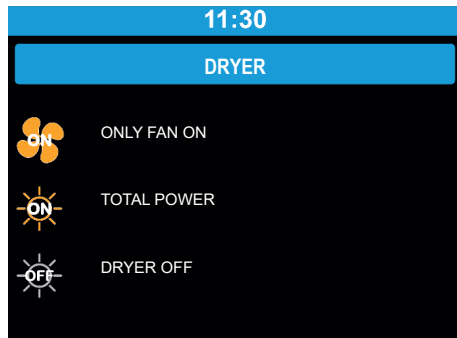

5.4 Select DRYER (option)

When the machine is in Ready or in Running mode, if present the optional **DRYER**. It allows enabling or disabling the DRYER's heating elements.

Press key **10 DRYER ON/OFF**

Use keys **5 ▲** (increase) and **6 ▼** (decrease) to select one of the following parameters:

ONLY FAN ON: enables only the fan(s) (heating elements disabled)

TOTAL POWER: enables the dryer(s) (fan(s) and heating elements enabled)

DRYER OFF: dryer completely disabled.

Confirm the selection by pressing key **9 CONFIRMATION**

The lower banner shows the icon of the selected mode.

Press key **14 RETURN** to exit without saving the settings.

5.5 Select SELF-CLEANING (option)

When the machine is in Stand-by mode and if present the optional **SELF-CLEANING**. It allows enabling **SELF-CLEANING** function.

Drain the tanks.

Press the key **12 SELF-CLEANING**

Use keys **5 ▲** (increase) and **6 ▼** (decrease) to select one of the following two parameters:

NO: the machine turns to Stand-by mode

YES: the function **SELF-CLEANING** is enabled. When the function is enabled, an automatic cycle of internal wash and rinse starts. At the end the machine turns to Stand-by mode again.

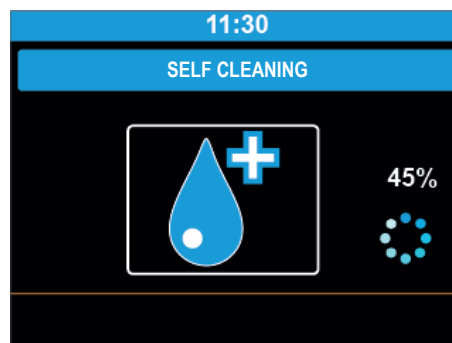
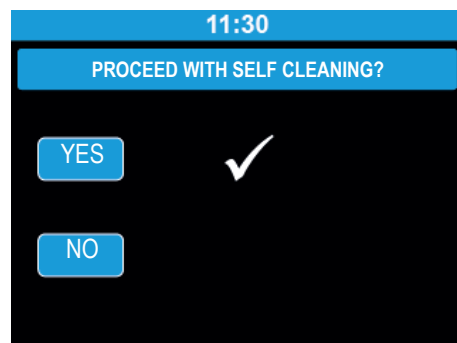

Dishes and cutlery loading

Before loading the dishes it is necessary to carry out a proper cleaning off of the food residuals.

It is not necessary to rinse the dishes with water before the loading.



WARNING: Do not wash items contaminated by petrol, paint, pieces of steel or iron, ash, sand, wax, lubricating grease. These substances damage the machine. Do not wash fragile items or made of material that do not stand the washing process.

Follow these tips:

- Crockery and cutlery must not lie inside one another, covering each other.
- Place the dishes so that all the surfaces can be reached by the water; otherwise the dishes cannot be washed properly.
- Make sure that the dishes are placed in a stable position and that the empty containers (cups, glasses, bowls, etc.) do not turn upside down.
- Place all the empty containers like cups, glasses, etc., **upside down**.
- Place in tilted position the dishes with deep hollows, so that the water can drain.
- Make sure that the smaller dishes do not fall from the baskets.
- Check that the dishes are not too tall or protruding.
- Do not wash trays horizontally.

Some food, like carrots, tomatoes, ketchup, may contain natural colorant substances that may alter the dishes and plastic parts if they are in large quantity.

The eventual color alteration does not mean that the plastic is not thermo-resistant.

Dishes to not wash in a dishwasher

Dishes not suitable to be washed in a dishwasher:

- Wooden crockery and cutlery or with wooden parts; wood wraps and loses its characteristics if it is exposed to high temperatures. In addition the glues used are not suitable for dishwashers; a consequence may be the handles detachment.
- Hand-made objects, valued vases or decorated glasses.
- Plastic dishes not thermo-resistant.
- Copper, brass, pewter or aluminum objects can discolor or become opaque.
- The decorations on glass can lose sparkle after a certain number of washes.
- Fragile glass or crystal objects can become opaque if washed many times.

It is suggested to purchase only crockery and cutlery suitable for washing in dishwashers.

Glasses can become opaque after many washes.

If after the washing the dishes are not clean or they have washing residuals (glasses, cups, bowls, etc., with liquid on the inside) it is mandatory to repeat the procedure.

NO →

pic. 6

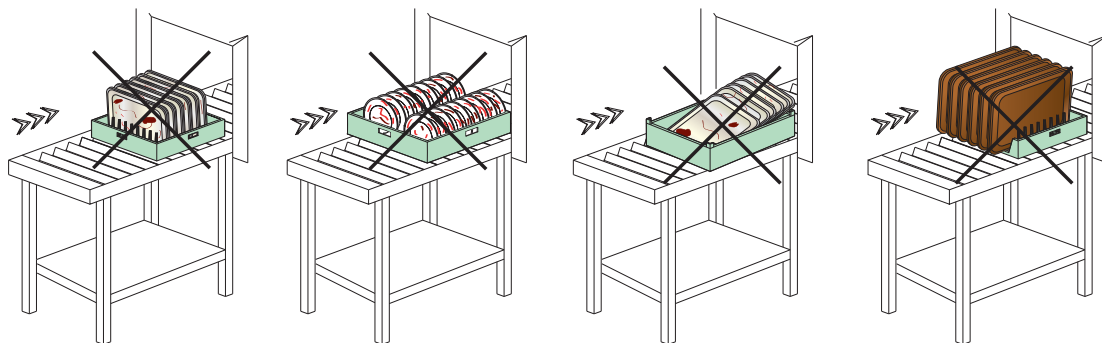

YES →

pic. 7

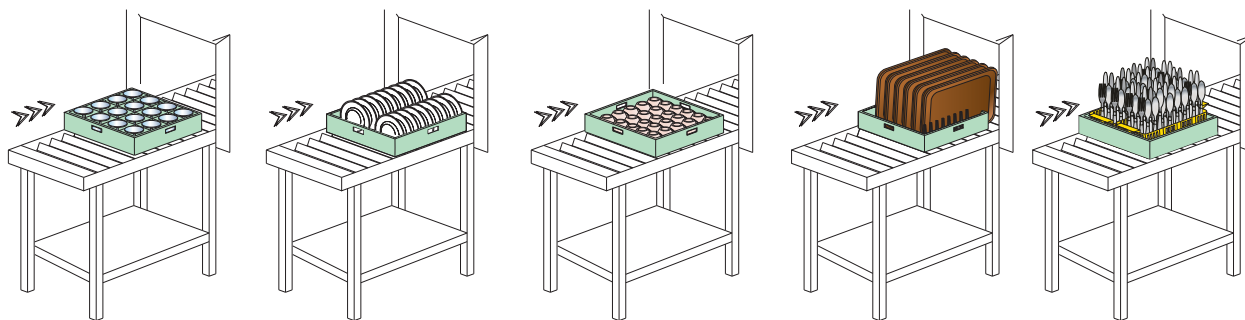

WARNINGS:

- Do not slam the doors when opening and closing.
- Do not put material or objects on the machine.
- The water used for the washing and the rinsing is not potable because of the presence of chemical additives. In case of contact with skin or eyes wash them immediately with plenty of water and check the safety instructions of the detergent manufacturer. If necessary, contact a doctor.
- Some important rules must be followed for the use of this appliance:
 - 1) Never touch the appliance with wet hands or feet
 - 2) Never use the appliance when barefooted
 - 3) Do not install the appliance in places exposed to water splashes.
- **This machine must be disconnected from the main electrical supply after use at the end of the day and for any service/maintenance operation. Switch off the circuit-breaker switch 16 located on the control panel. Shut the water supply valve(s).**
- In case an obstacle stops the conveyor, first turn off the circuit-breaker switch **16** (position **0** = machine not powered) and then remove the cause of the block.

WARNING: INTERNAL CLEANING OF THE MACHINE SHALL BE CARRIED OUT AT LEAST 10 MINUTES AFTER IT HAS BEEN TURNED OFF.

WARNING: DO NOT INSERT HANDS AND/OR TOUCH THE PARTS LOCATED AT THE BOTTOM OF THE WASH TANK AND/OR AT THE END OF THE WASH CYCLE.

WARNING: DO NOT TOUCH THE CONVEYOR WHILE IT IS WORKING.

DETERGENTS

Using detergent

The detergent must be of good quality, of NON-FOAMING type, specific for the mechanical washing of dishes.

The use of liquid detergents is recommended.

The dosing has to be done following the recommendations of the detergent manufacturer and in accordance with the water and dishes characteristics.

The detergent has to be inserted only in the wash tank 1. For manual dosing remember that the wash tank contains about 85 litres of water.

Note: It is forbidden to use detergents with chlorine-based reagents.

Using rinse aid

It is possible to use the rinse aid to get quicker drying and polishing.

The dosing has to be done following the recommendations of the rinse aid manufacturer and in accordance with the water characteristics.

Note: too much chemicals produces foam that reduces the effectiveness and lifetime of the washing pump.

Too much chemicals might leave residuals on the dishes.

Using sanitizing

It is forbidden to use sanitizing products with chlorine-based reagents.

Detergents and sanitizing products used to clean the machine must be properly prewashed.

It is forbidden to use generic detergents to clean the machine.

AIRBORNE NOISE EMISSIONS

The equivalent inlet maximum sound pressure level is the point **C** with $L_{Aeq} = 75,7 \text{ dB(A)}$.

The equivalent outlet maximum sound pressure level is the point **C** with $L_{Aeq} = 69,8 \text{ dB(A)}$.

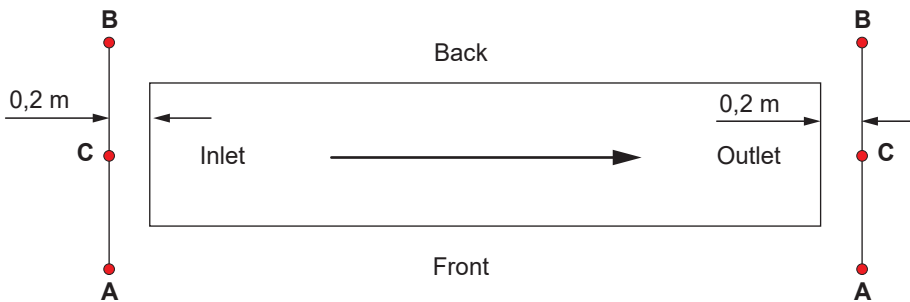

OBSERVANCE OF THE RULES OF HYGIENE AND H.A.C.C.P.

In order to meet the correct H.A.C.C.P. procedures remember to prepare a sheet with tables where the shift operator enters the date and time the washing starts, the time the washing ends, the tanks and boilers temperatures and any other note/alarms that have tripped and what he/she has done to ensure sanitary safety.

This is the reason why the machine is equipped with:

- Temperature gauges that indicate the boiler and tank temperature.
- Malfunctioning gauges.
- Possibility to consult the washing parameters.

MAINTENANCE

WARNING: The machine is not protected against pressure water jets, therefore avoid the use of this type of cleaning system on the cabinet.

It is also suggested to contact cleaning product dealers for detailed information about methods and products for a periodical sanitizing of the machine.

Do not use bleach or chlorine-based detergents to clean the machine.

Routine maintenance

The perfect operation of the machine depends on a careful cleaning that is necessary at least once a day with the following procedure:

- Turn off the machine as explained in the paragraph **End washing operations**.
- If the machine is equipped with Heat Recovery with heat pump, clean the extractable filter (see pic. 10).
- With empty tank, extract the filters of the tanks and the pumps (see pic. 8 - 9). Be careful that the washing residuals in the filters do not fall in the tanks. Clean the filters with a rigid brush underneath a powerful water jet.

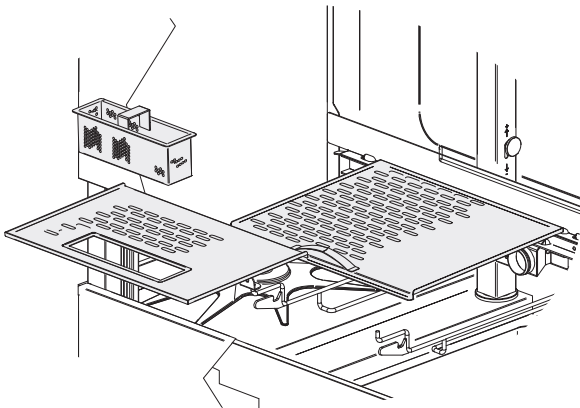

pic. 8

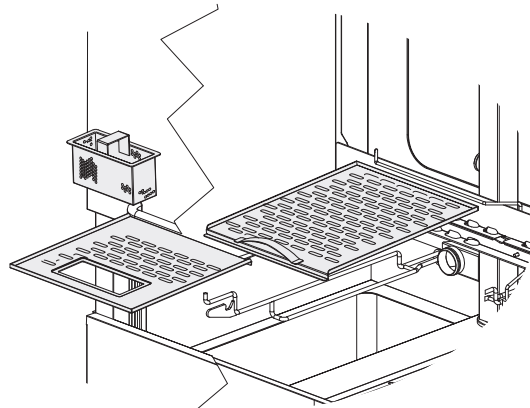

pic. 9

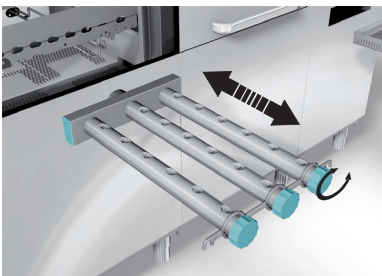
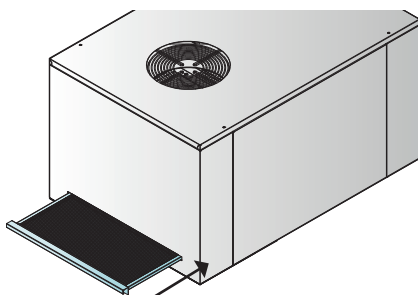

photo 1

- Extract the wash (see photo 1) and the rinse arms and carefully clean the nozzles underneath running water.
- Carefully clean the tanks avoiding the use of chlorine-based detergents.
- Clean the shutters (long on the outside, short on the inside).
- If the machine is equipped with automatic shower with drawer strainer, extract the drawer and clean it (see photo 2).
- Reassemble all the parts and replace the arms in their seats.
- It is suggested to leave the doors of the machine open at the end of the day.

Do not use a metal scouring pad and/or corrosive products to clean the dishwasher.

Do not use pressure cleaning systems.



pic. 10



photo 2

Extraordinary Maintenance – by qualified Service Personnel only

Once or twice per year, the machine should be checked by qualified Service Personnel:

- To remove scaling from the heating elements.
- To check the status and the tightness of all gaskets.
- To check the perfect state and/or wear of the components. If a component is damaged or oxidized replace it immediately, with genuine spare parts only.
- To check the efficiency of the dispensers.
- To tighten firmly all electrical connections at least once per year.
- To clean the intake filter of the solenoid valve.
- To check the state of the safety devices of the doors/boilers, limit switches.
- To check the calibration of the clutch.

Pay attention to do not wet the motor or any electric part. Perform maintenance with the circuit-breaker switch 16 turned OFF (in 0 position).

Every 3-4 years of machine use, double-check the tightening and the efficiency of all electrical contacts, with special attention to the contacts of starters and relays. Increase controls frequency if the machine is operating in heavy or intensive conditions.

Extraordinary Maintenance - Heat Recovery with heat pump option

Every two months the Heat Recovery should be checked by qualified Service Personnel to:

- Clean the finned exchangers inside the Heat Recovery.
- Check the heat pump's flow is properly charged.

Extraordinary Maintenance - Heat Recovery or Steam Condenser option

Every three months the Heat Recovery/Steam Condenser should be checked by qualified Service Personnel to:

- Clean the finned exchanger inside the Heat Recovery/Steam Condenser.

Extraordinary Maintenance - Pressure Increase Pump and/or Self-Cleaning pressure increase pump option

After long periods of inactivity of the dishwasher, check that the supplementary pressure increase pump freely rotate. Please contact the Technical Service.

ENVIRONMENTAL ASPECTS



Packing

The packing consists of the following:

- a wooden crate;
- extensible belt in nylon (LDPE);
- polystyrene foam (PS).

Please dispose of the materials listed above, in compliance with the legislation in force.

Disposal

The equipment is marked with the symbol (see pic. 11).

The symbol indicates that the product should not be discarded as unsorted waste **but must be sent to separate collection facilities for recovery and recycling in compliance with the legislation in force.**

An efficient waste disposal procedure contributes to avoiding any potential environmental or health hazards as well as promoting the recycling and re-utilization of materials from which our appliances are constructed. If the user does not comply with the regulations he/she shall be subject to the penalties foreseen by each member state.

Disconnect electricity and water before disposal.

All metal parts are recyclable as they are made of stainless steel.

Recyclable plastic parts are marked with the plastic material symbol.



pic. 11



ECOLOGICAL ASPECTS

Recommendations for optimum use of energy, water and additives

If possible, use the machine at full load: This will avoid wasting detergent, rinse aid, water and energy.

Detergents and rinse aids: Use detergents and rinse aids having the highest biodegradability so that the environment is better respected. Have the correct dosage according to the water hardness checked at least once a year. An excess of product pollutes rivers and seas, whereas an insufficient amount compromises dish washing and/or hygiene.

Tank and boiler temperatures: The temperatures of the tank and boiler are set by the manufacturer so as to get the best washing results with the majority of detergents on the market. These can be reset by the installer according to the detergent used.

Cleaning off: Carefully clean off the kitchenware using water at ambient temperature with moderation so as to make removal of animal fats easier. To remove encrusted matter, soaking in hot water is recommended.

Notes: Wash the objects as soon as possible in order to prevent the deposits from drying and jeopardizing the effectiveness of the washing. To get an efficient wash, it is advisable to regularly clean and maintain the dishwasher.

(see chap. **MAINTENANCE**).

Non-compliance with the above points and all the information described in this manual could determine a waste of energy, water and detergent, with consequent increase in operating costs and/or decrease in performance.

SIGNALS AND ALARMS

During the operation, the machine signals other situations in addition to alarms that need the operator attention.

In any case the relative information automatically appears on the display and remains visible until the operator execute the necessary actions.

To display the alarm/signal screen during the machine operation, press the **8 INFO**  key.

Press the **14 RETURN**  key to go back to the main screen.

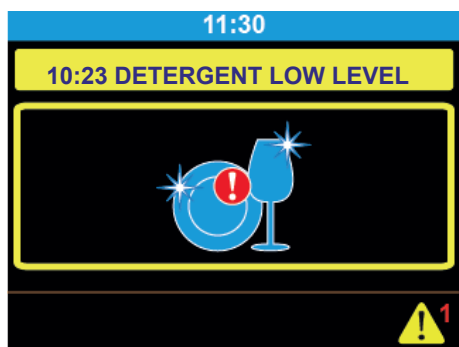

Signal screen example



Alarm screen example

Signals

The signal messages are displayed and signalized with a beep.

When **DETERGENT LOW LEVEL** appears on the display it means that the detergent is over.

When **RINSE AID LOW LEVEL** appears on the display it means that the rinse aid is over.

When **SANITIZER LOW LEVEL** appears on the display it means that the sanitizing product is over (only on machines equipped with the **SELF-CLEANING** optional).

When **DOOR OPEN** appears on the display it means that you are trying an operation that cannot be done with the door opened or that you opened the door and **interrupted** a cycle in progress.

When **DRAWER OPEN** appears on the display it means that you are trying an operation that cannot be done with the drawer opened or that you opened the drawer and **interrupted** a cycle in progress.

When **PLEASE DRAIN THE TANKS** appears on the display it means that you are trying an operation that cannot be done with the tanks full.

When **ENSURE THAT OUTLET IS CLEAR** appears on the display it means that it is necessary to remove the objects from the exiting shelf to continue the operation.

When **PERIODIC MAINTENANCE SUGGESTED** appears on the display it means that it is suggested to contact a technician for the periodical check of the machine.

When **ENERGY SAVING MODE** appears on the display it means that the machine is in energetic saving mode. (see par. **Available options**).

When **HEAT PUMP MAINTENANCE** appears on the display it means that you must call a technician for the Heat Recovery with heat pump maintenance (see paragraph **Extraordinary Maintenance - Heat Recovery with heat pump option** - only if the machine is equipped with the optional).

Alarms

The alarms are displayed on a dedicated screen that overlap the current display at the time the alarm occurs.

Each alarm screen gives precise information about the meaning of the alarm and which are the operation the operator can run.

Alarm screen example:

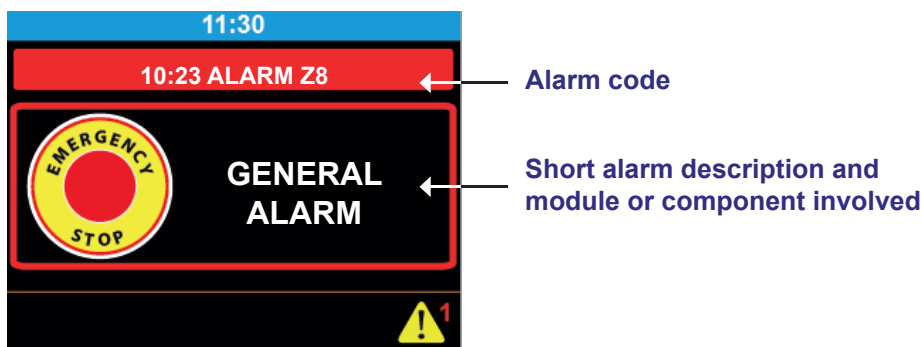



Alarm screen example

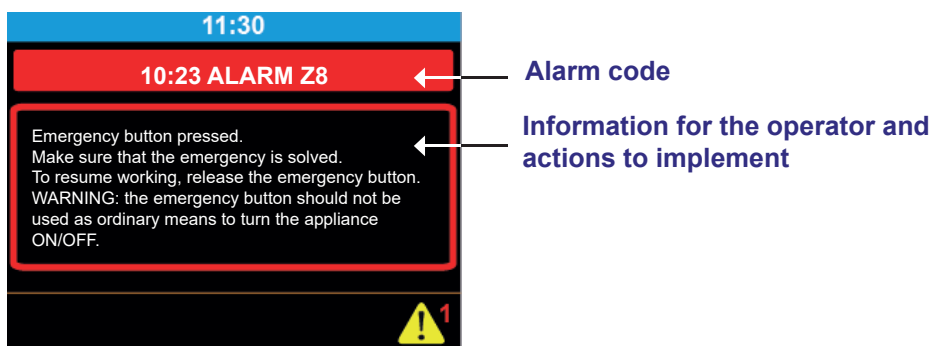

It is possible to have more information about the current alarm by pressing the **8 INFO**  key.



If the alarm does not block the machine it is possible to continue the operation by pressing **14 RETURN**  key. The machine will continue to signal the alarm until the resolution of the problem by:

- The symbol  is shown in the state of the machine.
- The **8 INFO**  key. In this case by pressing the **8 INFO**  key the current alarm is displayed.

If the alarm block the machine the operator will be able to carry out only two actions:

- Press the **8 INFO**  key to have more information
- Press the **4 ON/OFF**  to position the machine in stand-by.



Alarms description

Alphanumeric abbreviation	Alarm description
ALARM B2	BOILER 1 PROBE FAILURE
ALARM B3	BOILER 1 HEATING FAILURE
ALARM B5	BOILER 1 OVERTEMPERATURE
ALARM B10	RINSE LOW TEMPERATURE
ALARM C1	PRE-RINSE FILLING FAILURE
ALARM C6	PRE-RINSE DRAINING FAILURE
ALARM C7	PRE-RINSE PUMP THERMAL PROT.
ALARM E1	WASH TANKS FILLING FAILURE
ALARM E2	WASH1 PROBE FAILURE
ALARM E3	WASH1 HEATING FAILURE
ALARM E4	WASH1 LOW TEMPERATURE
ALARM E5	WASH1 OVERTEMPERATURE
ALARM E6	WASH DRAINING FAILURE
ALARM E7	WASH1 PUMP THERMAL PROTECTION
ALARM F2	WASH2 PROBE FAILURE
ALARM F3	WASH2 HEATING FAILURE
ALARM F4	WASH2 LOW TEMPERATURE
ALARM F5	WASH2 OVERTEMPERATURE
ALARM F7	WASH2 PUMP THERMAL PROTECTION
ALARM M1	PREWASH FILLING FAILURE
ALARM M2	PREWASH PROBE FAILURE
ALARM M3	PREWASH COOLING FAILURE
ALARM M5	PREWASH OVERTEMPERATURE
ALARM M6	PRE-WASH DRAINING FAILURE
ALARM M7	PREWASH PUMP THERMAL PROT.
ALARM N2	SHOWER PROBE FAILURE
ALARM N7	SHOWER PUMP THERMAL PROT.
ALARM U1	RINSE PUMP THERMAL PROTECTION
ALARM U3	EXTRACTOR MOTOR THERMAL PROT.
ALARM U4	BLOWER MOTOR THERMAL PROT.
ALARM U7	SELF-CLEAN. PUMP THERMAL PROT.
ALARM U9	HEAT PUMP THERMAL PROT.
ALARM U10	OPTIONAL MOTORS THERMAL PROT.
ALARM W1	INVERTER THERMAL PROTECTION
ALARM X2	INLET WATER PROBE FAILURE
ALARM Z8	GENERAL ALARM
ALARM Z14	BREAK TANK FILLING FAILURE
ALARM Z15	BREAK TANK DRAINING FAILURE
ALARM Z16	SELF-CLEAN. WATER SUPPLY FAIL.
ALARM Z17	RINSE WATER SUPPLY FAILURE

ALARM B2 BOILER 1 PROBE FAILURE

Rated temperature cannot be reached.

It's recommended to suspend the washing.

Please contact the Rhima Service Department.

ALARM B3 BOILER 1 HEATING FAILURE

Please turn **OFF** the appliance, by pressing the **ON/OFF 4**  button, and turn it **ON** again, after a few seconds. Should the alarm persists, please contact the Rhima Service Department.

ALARM B5 BOILER 1 OVERTEMPERATURE

It is recommended to turn **OFF** the appliance and contact the Rhima Service Department.

ALARM B10 RINSE LOW TEMPERATURE

Please make sure that rinse arms and nozzles are in the right position.

Should the alarm persists, please contact the Rhima Service Department.

ALARM C1 PRE-RINSE FILLING FAILURE

Please check that water inlet connection is working.

Please turn **OFF** the appliance, by pressing the **ON/OFF 4**  button, and turn it **ON** again, after a few seconds. Should the alarm persists, please contact the Rhima Service Department.

ALARM C6 PRE-RINSE DRAINING FAILURE

Please check that the drain of the tank is not clogged.

Please turn **OFF** the appliance, by pressing the **ON/OFF 4**  button, and turn it **ON** again, after a few seconds. Should the alarm persist, please contact the Rhima Service Department.

ALARM C7 PRE-RINSE PUMP THERMAL PROT.

Rinse results may be affected.

Please contact the Rhima Service Department.

ALARM E1 WASH TANKS FILLING FAILURE

Please check that water inlet connection is working.

Please turn **OFF** the appliance, by pressing the **ON/OFF 4**  button, and turn it **ON** again, after a few seconds. Should the alarm persists, please contact the Rhima Service Department.

ALARM E2 WASH1 PROBE FAILURE

Rated temperature cannot be reached.

Washing results may be affected.

Please contact the Rhima Service Department.

ALARM E3 WASH1 HEATING FAILURE

Please turn **OFF** the appliance, by pressing the **ON/OFF 4**  button, and turn it **ON** again, after a few seconds. Should the alarm persists, please contact the Rhima Service Department.

ALARM E4 WASH1 LOW TEMPERATURE

The washing results may be affected.

Please check if the curtains are properly placed and that dishes are well-positioned in the racks.

It is recommended to suspend washing until the right temperature is reached.

Should the alarm persists, please contact the Rhima Service Department.

ALARM E5 WASH1 OVERTEMPERATURE

It is recommended to turn **OFF** the appliance and contact the Rhima Service Department.

ALARM E6 WASH DRAINING FAILURE

Please check that the drain of the tanks is not clogged.

Please turn **OFF** the appliance, by pressing the **ON/OFF 4**  button, and turn it **ON** again, after a few seconds. Should the alarm persist, please contact the Rhima Service Department.

ALARM E7 WASH1 PUMP THERMAL PROTECTION

It's recommended to suspend the washing.

Please contact the Rhima Service Department.

ALARM F2 WASH2 PROBE FAILURE

Washing results may be affected.

Please contact the Rhima Service Department.

ALARM F3 WASH2 HEATING FAILURE

Please turn **OFF** the appliance, by pressing the **ON/OFF 4**  button, and turn it **ON** again, after a few seconds. Should the alarm persists, please contact the Rhima Service Department.

ALARM F4 WASH2 LOW TEMPERATURE

The washing results may be affected.

Please check if the curtains are properly placed and that dishes are well-positioned in the racks.

It is recommended to suspend washing until the right temperature is reached.

Should the alarm persists, please contact the Rhima Service Department.

ALARM F5 WASH2 OVERTEMPERATURE

It is recommended to turn **OFF** the appliance and contact the Rhima Service Department.

ALARM F7 WASH2 PUMP THERMAL PROTECTION

Washing results may be affected.

Please contact the Rhima Service Department.

ALARM M1 PREWASH FILLING FAILURE

Please check that water inlet connection is working.

Please turn **OFF** the appliance, by pressing the **ON/OFF 4**  button, and turn it **ON** again, after a few seconds. Should the alarm persists, please contact the Rhima Service Department.

ALARM M2 PREWASH PROBE FAILURE

Washing results may be affected.

Please contact the Rhima Service Department.

ALARM M3 PREWASH COOLING FAILURE

Please check that the cold water inlet connection is working.

Please turn **OFF** the appliance, by pressing the **ON/OFF 4**  button, and turn it **ON** again, after a few seconds. Should the alarm persists, please contact the Rhima Service Department.

ALARM M5 PREWASH OVERTEMPERATURE

Washing results may be affected.

Please check that the cold water inlet connection is working.

Should the alarm persists, please contact the Rhima Service Department.

ALARM M6 PRE-WASH DRAINING FAILURE

Please check that the drain of the tanks is not clogged.

Please turn **OFF** the appliance, by pressing the **ON/OFF 4**  button, and turn it **ON** again, after a few seconds. Should the alarm persist, please contact the Rhima Service Department.

ALARM M7 PREWASH PUMP THERMAL PROT.

Washing results may be affected.

Please contact the Rhima Service Department.

ALARM N2 SHOWER PROBE FAILURE

Please contact the Rhima Service Department.

ALARM N7 SHOWER PUMP THERMAL PROT.

Washing results may be affected.

Please contact the Rhima Service Department.

ALARM U1 RINSE PUMP THERMAL PROTECTION

Please contact the Rhima Service Department.

ALARM U3 EXTRACTOR MOTOR THERMAL PROT.

It's recommended to suspend the washing.

Please contact the Rhima Service Department.

ALARM U4 BLOWER MOTOR THERMAL PROT.

Please contact the Rhima Service Department.

ALARM U7 SELF-CLEAN. PUMP THERMAL PROT.

Please contact the Rhima Service Department.

ALARM U9 HEAT PUMP THERMAL PROT.

Please contact the Rhima Service Department.

ALARM U10 OPTIONAL MOTORS THERMAL PROT.

Please contact the Rhima Service Department.

ALARM W1 INVERTER THERMAL PROTECTION

Please contact the Rhima Service Department.

ALARM X2 INLET WATER PROBE FAILURE

Please contact the Rhima Service Department.

ALARM Z8 GENERAL ALARM

Emergency button pressed.

Make sure that the emergency is solved.

To resume working, release the emergency button.

WARNING: the emergency button should not be used as ordinary mean to turn the appliance **ON/OFF**.

ALARM Z14 BREAK TANK FILLING FAILURE

Check if the water supply is working.

Please turn **OFF** the appliance, by pressing the **ON/OFF 4**  button, and turn it **ON** again, after a few seconds. Should the alarm persists, please contact the Rhima Service Department.

ALARM Z15 BREAK TANK DRAINING FAILURE

Please make sure that rinse nozzles are not clogged.

Please turn **OFF** the appliance, by pressing the **ON/OFF 4**  button, and turn it **ON** again, after a few seconds. Should the alarm persists, please contact the Rhima Service Department.

ALARM Z16 SELF-CLEAN. WATER SUPPLY FAIL.

Please check if the water supply is working and make sure that self-cleaning arms are in the proper position.

Please turn **OFF** the appliance, by pressing the **ON/OFF 4**  button, and turn it **ON** again, after a few seconds. Should the alarm persists, please contact the Rhima Service Department.

ALARM Z17 RINSE WATER SUPPLY FAILURE

Please check if the water supply is working and make sure that rinse arms and nozzles are in the proper position.

Please turn **OFF** the appliance, by pressing the **ON/OFF 4**  button, and turn it **ON** again, after a few seconds. Should the alarm persists,

Please contact the Rhima Service Department.



MACHINE PROBLEMS, CAUSES AND CURES

Type of problem	Possible causes	Cure
The machine does not start	Main switch turned off	Turn on the main switch
	Card transformer fuse blown	Contact Rhima Service Department to replace the fuse
The machine does not load water	Water supply valve closed	Open the water supply valve
	Shortage of supply water pressure	Turn off and turn back on when the pressure increases or install a booster pump
	Solenoid valve filter clogged with sand	Contact the Rhima Service Department to clean the filter
Inadequate washing results	The washing nozzles are clogged	Clean the nozzles and correctly reposition the arms in the proper seats
	Detergent concentration too low	Change the dosage of detergent
	Filters too dirty	Remove and clean the filters with a brush under a jet of water, then replace them in their seats
	Presence of foam	Always use a non-foaming detergent. Check the detergent and rinse aid dosages and reduce them if necessary.
	Check the tank temperature	Adjust the temperature set for the washing. Contact the Rhima Service Department to check the correct operation of the heating element
	Washing duration not sufficient for the type of dirty	Select the lowest speed or repeat the washing cycle
	Washing water too dirty	Drain the water of the tanks, clean the filters. Reload the tank and replace the filters properly
	The machine doesn't rinse	Contact the Rhima Service Department
The objects are not dried properly	Insufficient rinse aid dosage	Check the dosage of rinse aid and increase it if necessary
	Baskets unsuitable for the objects	Use a basket suitable for the objects
	Rinse water temperature too low	Check the temperature of the water entering the system
Streaks or smears on the objects	Rinse aid concentration too high	Always use a non-foaming detergent. Check the detergent and rinse aid dosages and reduce them if necessary.
	Water too hard	Check the water quality. The water hardness must not be higher than 8 °f
During the operation the machine suddenly stops	The machine is connected to an overloaded system	Contact the Rhima Service Department to connect the machine separately
	A machine safety device tripped	Contact the Rhima Service Department to check the security devices
During the washing phase the machine stops and replenishes the water	The water of the previous day has not been changed	Empty the tank and carry out a new filling
	Faulty pressure switch	Contact the Rhima Service Department
	Overflow/drain pipe positioned incorrectly	Remove and correctly reposition the overflow/drain pipe
	A tank emptied due to excess of foam or lack of curtains/splash guards	Reduce the concentration of rinse aid/detergent or correctly reposition the curtains or the other guards that may have been removed
	Wash arms incorrectly positioned	Check and correctly reposition the wash arms

Type of problem	Possible causes	Cure
The machine does not wash and the pump is noisy on machines with three-phase pump	The pump direction is inverted due to incorrect connection of the power supply cable	Contact the Rhima Service Department
	The level of water inside the tank is too low	Remove and correctly replace the overflow/drain pipe
		Correctly reposition the curtains or the other guards that may have been removed
		Check and correctly reposition the wash arms
	If the level of water continues to fall, contact the Rhima Service Department	
	The suction of the pump is clogged	Check if the suction filters of the pump (placed in the tanks) are clogged. If the problem persists contact the Rhima Service Department.

OPTIONALS PROBLEMS, CAUSES AND CURES

Heat recovery with heat pump

Type of problem	Possible causes	Cure
Compressor attach/detach	Safety pressure switches intervention	Contact the Rhima Service Department
	Water temperature supply too high	Verify the water temperature supply
	Water capacity not sufficient	Verify the static pressure
	Dirty steam coil	Clean the filter. Should the alarm persists, please contact the Rhima Service Department to clean the Heat Recovery
Low boiler temperature	Dirty steam coil	Clean the filter. Should the alarm persists, please contact the Rhima Service Department to clean the Heat Recovery
	Heat pump has lost gas	Contact the Rhima Service Department
	The Heat Recovery has been switched OFF and then switched ON	Wait a couple of minutes to restart the compressor and that the boiler temperature is restored
	Safety pressure switches intervention	Contact the Rhima Service Department
The objects are not dried properly	Insufficient rinse aid dosage	Verify the rinse aid dosage and increase it, if needed
	The basket is not suitable to the objects	Use basket suitable for the objects
	Dirty steam coil	Clean the filter. Should the alarm persists, please contact the Rhima Service Department to clean the Heat Recovery unit.
	Heat pump has lost gas	Contact the Rhima Service Department
Dirty coil alarm	Dirty steam coil	Contact the Rhima Service Department (it is possible to keep dishwashing, for a limited time, while the filter is under cleaning)

Heat Recovery

Type of problem	Possible causes	Cure
Low boiler temperature	Dirty steam coil	Should the alarm persists, please contact the Rhima Service Department to clean the Heat Recovery
	The ventilation motor is damaged	Contact the Rhima Service Department
The objects are not dried properly	Insufficient rinse aid dosage	Verify the rinse aid dosage and increase it, if needed
	The basket is not suitable to the objects	Use basket suitable for the objects
	Dirty steam coil	Should the alarm persists, please contact the Rhima Service Department to clean the Heat Recovery

Dryer

Type of problem	Possible causes	Cure
The objects are not dried properly	Cold air is emitted	Contact the Rhima Service Department
	The fan direction is inverted due to incorrect power cable connection	Contact the Rhima Service Department

Pressure increase pump

Type of problem	Possible causes	Cure
Inadequate washing results	The machine doesn't rinse	Contact the Rhima Service Department

Break Tank

Type of problem	Possible causes	Cure
Inadequate washing results	The machine doesn't rinse	Contact the Rhima Service Department
	Water capacity not sufficient	Verify the static pressure

N.B.: For any other problems, contact the Rhima Service Department. The Manufacturer reserves the right to modify the technical characteristics without prior notice



Australia

Tel: 1300 347 944

New Zealand

Tel: 0800 902 054

Singapore

Tel: +65 9107 8943

Version 1.0

DETERGENTS

To request detergents or rinse additive contact your local Rhima Service centre below:

Australia: **1300 347 944**

New Zealand: **0800 902 054**

Singapore: **+65 9107 8943**



Superwash

10L Drum

For all other washing

