

Operator's Manual



RP 3 & RP 3 HR Washer



INSTRUCTION MANUAL FOR DISHWASHERS



It is important to keep this instruction manual near the appliance for future consultation.

If the appliance is sold or transferred to another user, make sure this manual remains with the appliance so that the new owner is informed about the warnings and operation of the appliance. These instructions are given for safety reasons and they must be read carefully before installing or using the appliance.

GENERAL INSTRUCTIONS

- The appliance must be connected to water and electrical supplies by qualified tradespersons only and according to local regulations.
- The appliance must be used by adults only. Do not let children play with, or operate this machine.
- Only persons trained to use this dishwasher are permitted to operate it.
- This appliance has been designed to wash food preparation and eating utensils. It has NOT been designed to wash objects soiled with petrol, paint, remnants of steel or iron, corrosive chemical products such as acids, alkalis, or solvents or any item that cannot be immersed in water.
- Do not open the appliance door or lift hood while the appliance is operating. The appliance has a safety device which stops operation if the door or hood is accidentally opened.
- After using the appliance, isolate the electric and water supply.
- Do not attempt to repair the appliance. Repairs made by unqualified persons may cause further damage and will void warranty.
- Repairs and servicing of this appliance must be carried out by Rhima personnel only.

IMPORTANT CUSTOMER INFORMATION

- To request a service, detergents or rinse additive contact your local Rhima Service centre below:

Australia: **1300 347 944**

New Zealand: **0800 902 054**

Singapore: **+65 9107 8943**

ELECTRICAL INSTALLATION

This appliance is intended to be connected to a **3 x 20 Amps** electrical supply and **must be earthed**.

PLUMBING INSTALLATION

The Australian installation shall be in accordance with The Plumbing Code of Australia (PCA).

This appliance should be connected to a hot water supply (Max 65°C) for in accordance with Australian Standard AS/NZS 3500.1. for optimum performance.

The water supply pressure should be a minimum 200 kPa at all times and flow rate should be at least 10 litres per minute. A static pressure higher than 600 kPa (73.5 psi) requires a pressure reducing valve upstream of the supply line. If water pressure is below 150 kPa, the use of a rinse booster pump is recommended.

This appliance is designed to drain to a tundish. Waste connection to a spigot is not recommended and may cause draining issues.

The drainpipe should withstand 70°C (158°F) in continuous duty conditions.

The grey water drain hose must have a fixed watertight seal above the tundish in accordance with the Australian Standard AS/NZS 3500.2.

A DIAGRAM SHOWING THE CORRECT METHOD OF WASTE INSTALLATION IN ACCORDANCE WITH THE AUSTRALIAN STANDARD AS/NZS 3500.2 IS BELOW



INSTALLATION TO BE IN ACCORDANCE WITH AUSTRALIAN STANDARD AS/NZS 3500.2

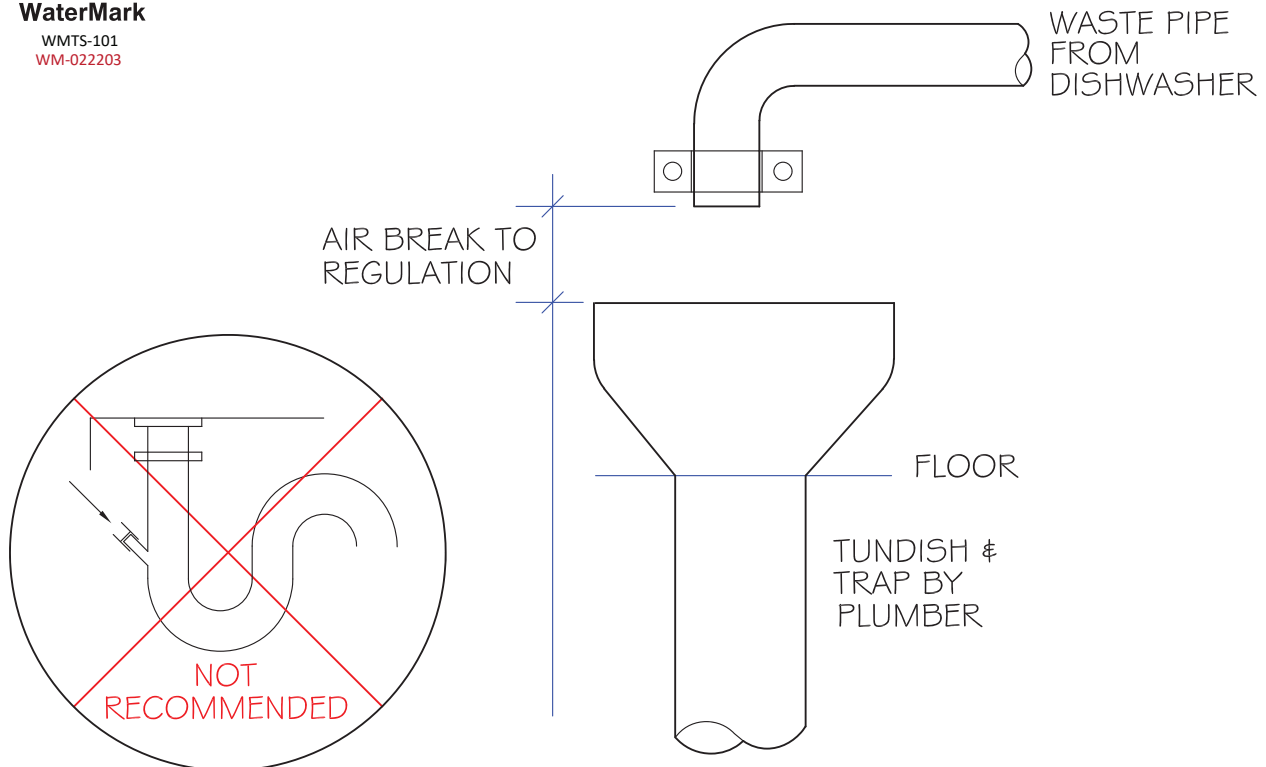

GRAVITY WASTE

CONTROL PANEL AND RELATIVE SYMBOLS

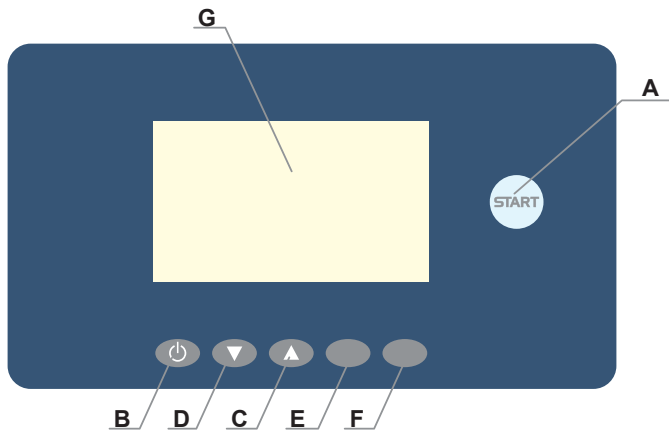

- A:** Cycle Start/Stop
- Multi-chromatic button:** Firm red light: machine filling/heating;
Flashing red light: alarm signal (check the code on the alarm chart);
Green light: machine ready. Select cycle;
Firm blue light: machine in operation;
Flashing blue light: machine in stand-by.
- B:** Machine power ON/OFF (in stand-by only)
- C:** Cycle Selection
- D:** Cycle Selection
- E:** Drain Valve Control
- F:** Info
- G:** LCD Display

OPERATION

Machine start-up

Start-up

- Put the surface filters in place. **DO NOT use the appliance without the filters..**
- Close the dishwasher door.
- Open the water valve.
- Turn the main power switch ON. The message **Firmware** is displayed for a few seconds.
- The machine is on **STAND-BY**. The display will show **STAND-BY** or **LOGO**.
- Turn the button **B**..

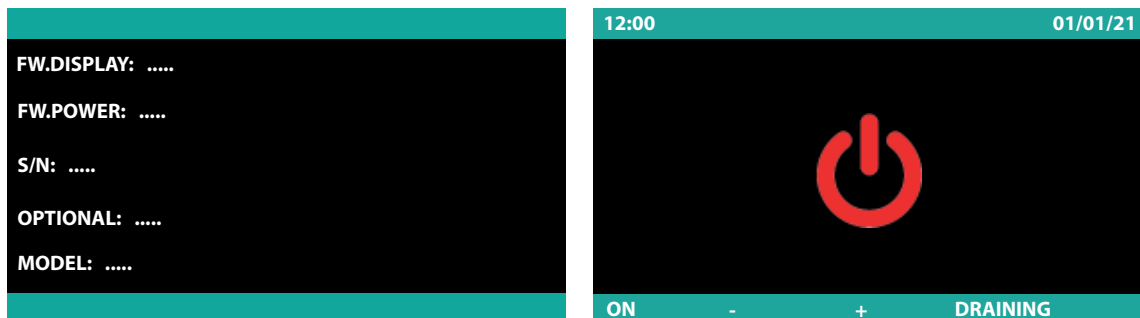

The machine start will be active when the **A** button will light.

On the display the **STAND-BY** message will be off.

The button **A** will light in white for a few seconds, while loading the software. After loading is complete, the button will light in red. At this moment, the water filling starts. The display will read **FILLING WATER**.

Should the machines be equipped with the WRAS certified Break Tank, the tank filling phase is extended.

Once the filling is done, the heating phase will start on the display will appear the reading **HEATING**. The reading will stay until both boiler and wash-tank will reach the set temperatures. During this process, the machine will not allow any cycle selection or start.

During this phase the **AUTOMATIC START** function can be enabled (see paragraph **Operation**).

After the filling/heating is completed, the key **A** and the display will turn green.



Operation

- Insert the rack filled with objects to wash (see paragraph **Objects loading**).
- Select the desired wash program by the keys **C** and **D** or by keeping pressed the **A** key. Release the key when the selected program is selected. To start the selected cycle press the **A** key, the button **A** will turn blue
- All wash-time long the display will read the wash-tank temperature and the boiler temperature.

Beneath the Temperatures Display will appear the Cycle Progress Bar (in percentage).

At the end of the washing cycle, a hot rinse cycle will take place.

A blue/green flashing on the button **A** will indicate the cycle ended.

The display shows **CYCLE ENDED** message.

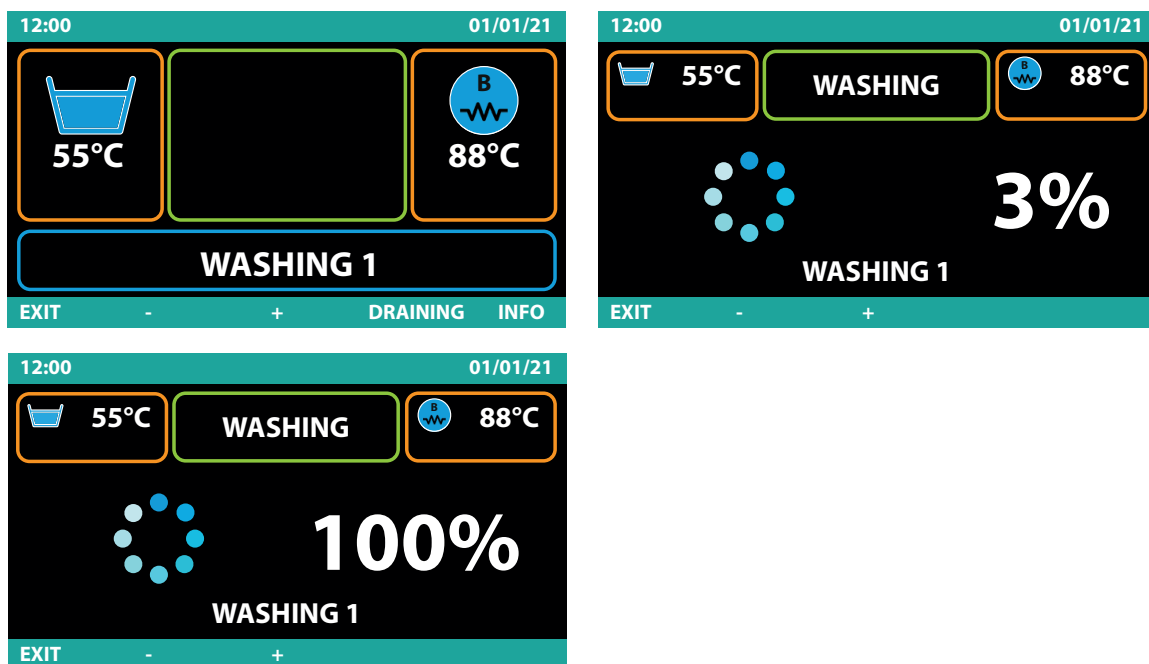

Note: At cycle-end, keeping the door closed, objects will not dry. Extract the rack or keep the door open to allow evaporation, helping the drying of the objects.

When opening the door, the button **A** will turn green, indicating that the machine is ready for a new wash-cycle.

Note: The last cycle used remain in the memory of the electronic board.

We recommend to change water at least twice a day, or whenever needed.

AUTOMATIC START: This function enables a self-activated wash cycle, when the filling/heating phase is completed.



AUTOMATIC START activation:

- Keep pressed for 10 seconds the Key **A** during the filling or heating phase.
- Within 30 seconds select the wash cycle by pressing either **C** or **D** Keys and confirm by pressing **A**. The display will show **AUTOMATIC START**.
- If this does not happen, repeat the procedure.

Switching OFF

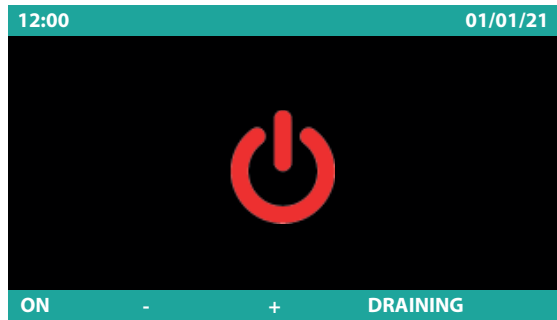

- Turn the button **B**. The display will show **STAND-BY** or **LOGO**.
- At the end of the day, clean the machine (see chapter **MAINTENANCE**).
- Shut the water valve.
- Turn off the main wall switch.
- At the end of the day, it is advisable to leave the dishwasher door open.

Objects loading

Before objects loading in the machine, coarsely clean them from the leftover food. It isn't necessary to rinse the objects under water.



WARNING: Do not wash articles polluted with petrol, paint, chips of steel or iron, ash, sand, wax, lubricant grease. These substances damage the machine. Do not wash fragile objects or material not resistant to the washing process.



Note the following recommendations:

- Objects should not be inserted inside one another, covering each other.
- Place the objects in order to all surfaces can be reached by water; otherwise the objects are not washed.
- Make sure all the objects are in a stable position and that the hollow containers don't overturn (baskets, pots, pans, bowls, etc.) .
- Place in the rack all the hollow containers such as baskets, pots, pans, bowls, etc. **upside-down**.
- Place the objects with deep hollow with upper face downwards, so that water can flow out.
- Make sure the smaller objects do not fall from the rack.
- Check all the wash arms runs freely and they are not blocked by too tall or too prominent objects. Eventually, run a manual rotation of the arms to check it.

Some foods, such as carrots, tomatoes, and others, may contain some natural dyes substances, that in large amounts, can alter the objects and plastic parts colors. Any discoloration does not mean that the plastic is not heat resistant.

Objects not suitable for dishwasher

Not suitable for dishwasher:

- Wooden objects or with wooden parts; water at high temperature causes deformation to wood. Also the adhesives used are not suitable for treatment in the dishwasher; a consequence could be the handles detachment
- Crafts or precious vases
- Not heat-resistant plastic objects.
- Copper, brass, pewter or aluminum objects: they may become discolored or opaque.
- The decorations on glass, after a certain number of washes, can lose gloss.

We recommend to buy exclusively objects suitable for dishwashing.

It is mandatory to repeat the washing cycle if at the end of the cycle the objects are not well clean or if there are washing residues (baskets, pots, pans, bowls, etc. with liquid inside).

Use of detergent

The machine can be equipped with the detergent dispenser. If provided, the machine will automatically take the needed detergent amount

The detergent shall be the NO FOAM type, suitable for industrial dishwashers.

The detergent must be introduced in the tank. The use of good quality liquid detergents is recommended. By request the dishwasher can be equipped with an electric detergent dispenser (always recommended).

Follow the manufacturer's recommendations for chemical dosage, related to the local water hardness. 1cm. of the product drawn into the tube is equal to about 0.15 g. A correct amount of detergent is very important for a successful wash.

Should the detergent lack, the display will show DETERGENT LEVEL (only with optional "Sensor for Chemicals Low Level").



Use of rinse aid

The machine has a standard rinse aid dispenser. The machine automatically sucks the product.

The rinse-aid chemical, shall be suitable for professional dishwashers.

Should the detergent lack, the display will show RINSE-AID LEVEL (only with optional "Sensor for Chemicals Low Level").



MAINTENANCE

WARNING: The machine is not protected against pressurized water jets. Do not use pressure cleaning system against the machine. Do not use bleach or chlorine based detergents.

It is recommended to contact the seller of chemicals for proper cleaning instructions, in order to have detailed indications on methods and products for the correct periodical machine sanitation.

Regular Maintenance

In order to ensure perfect performance, the appliance must be completely cleaned at least once a day in the following way:

- Turn the machine in **STAND-BY** mode, by pressing the push-button **B** on the control panel (see chapter **OPERATION**).
- Remove the surface filters and clean them under running water (see Pict. 6).
- Drain the sump water by pressing button **E** on the control panel to select **DRAINING**.
If the drain hose is elevated above the drain point of the machine the machine will not drain.
- Remove the rotors by loosening the fixing screws, and thoroughly clean the nozzles and cleaning and rinsing arms under running water (see Pict. 7).
- Remove the heat exchanger filter (if installed) and clean it under running water (see Pict. 8).

- Reassemble the parts and reposition the wash pipes. Take extreme care to re-assemble the nozzles in the right position (open and / or closed nozzles) and that the arms are installed with the right axial angle.
- Clean the tub thoroughly using specific products.
- At the end of the day, it is advisable to leave the dishwasher door open.
- **Automatic cycle of machine self-cleaning/rinsing:** recommended at each day end. With the machine on **STAND-BY** mode and, when the tank is empty, press the **A** key; an automatic cycle of 60 seconds will start, after this the machine will be in **STAND-BY** mode.
- Turn off the water tap.
- Turned off the machine by switching the main power switch OFF.



Pict. 6

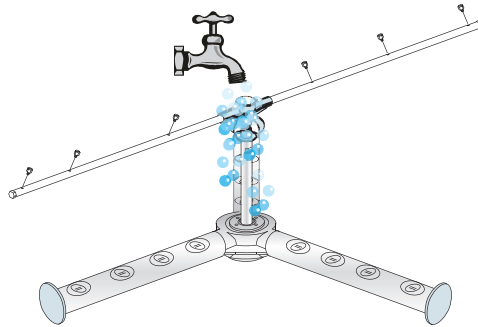

Pict. 7

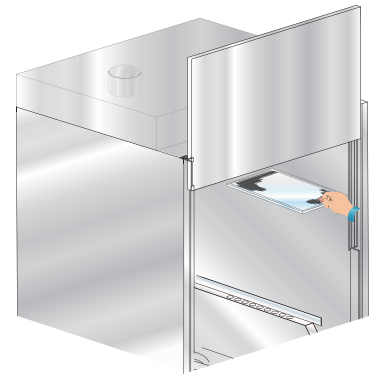

Pict. 8

Special Maintenance

Once or twice a year have a qualified technician inspect the machine:

- 1 To clean the electrovalve filter.
- 2 To remove residual deposits.
- 3 To check the watertight of the seals for water loading and unloading connections.
- 4 Check the perfect state and/or wear of the components.
- 5 The operation of the dispensers.
- 6 Check the efficiency of the door safety switch.
- 7 A qualified electrician, should check all electric connections inside the machine, at least once a year.

Every 3-4 years of machine use, double-check the tightening and the efficiency of all electrical contacts, with special attention to the contacts of starters and relays.

Increase controls frequency if the machine is operating in heavy or intensive conditions.

Compliance with hygiene regulations and H.A.C.C.P.

- When starting the machine ON, no wash-cycle will be starting until the set boiler and wash-tank temperatures are reached. During operation, the machine will not start the rinse cycle till the set boiler temperature is reached.
- Scrape food from the dishes carefully in order not to clog the filters, nozzles and pipes.
- Unload the wash tub and clean the filters at least twice a day.
- Check if the detergent and rinse-aid dosage are correct (as recommended by the manufacturer). In the morning, before starting the machine, check that the quantity of chemicals in the canisters is enough for daily supply.
- Always clean the support floor of the dishes.
- Extract the rack with clean hands or gloves to avoid finger marks.
- Do not dry or polish the dishes with non-sterilized cloths, brushes, or dusters.

ECOLOGICAL ASPECTS

Recommendations for optimum use of energy, water and additives

- If possible, use the machine at full load: This will avoid wasting detergent, rinse aid, water and energy.
- Detergents and rinse aids: Use detergents and rinse aids having the highest biodegradability so that the environment is better respected. Have the correct dosage according to the water hardness checked at least once a year. An excess of product pollutes rivers and seas, whereas an insufficient amount compromises dish washing and/or hygiene.
- Tank and boiler temperatures: The temperatures of the tank and boiler are set by the manufacturer so as to get the best washing results with the majority of detergents on the market. These can be reset by the installer according to the detergent used..
- Cleaning off: Carefully clean off the kitchenware using water at ambient temperature with moderation so as to make removal of animal fats easier. To remove encrusted matter, soaking in hot water is recommended.

Notes: Wash the objects as soon as possible in order to prevent the deposits from drying and jeopardizing the effectiveness of the washing.

To get an efficient wash, it is advisable to regularly clean and maintain the dishwasher (see chapter **MAINTENANCE**).

Non-compliance with the above recommendations or with any and all information within the manual could result in a waste of energy, water, and detergent, further causing an increase in user costs and/or a reduction in performance.

SIGNALS AND ALARMS



Signals

During the operation, the machine signals other situations in addition to alarms that need the operator attention.

In any case the relative information automatically appears on the display and remains visible until the operator execute the necessary actions.

Signals description

The signals messages are displayed, based upon their meaning.

When displaying **DETERGENT LEVEL** add detergent in the detergent tank (only with optional "Sensor for Chemicals Low Level").

When displaying **RINSE-AID LEVEL** add rinse-aid chemical in the rinse-aid tank (only with optional "Sensor for Chemicals Low Level").

When displaying **DOOR OPEN** means that the open door does not allow the maneuver tried, or a wash cycle was in progress, when lifting the door.

When the display shows **DRAIN VALVE OPEN** it indicates that the drain valve does not close.

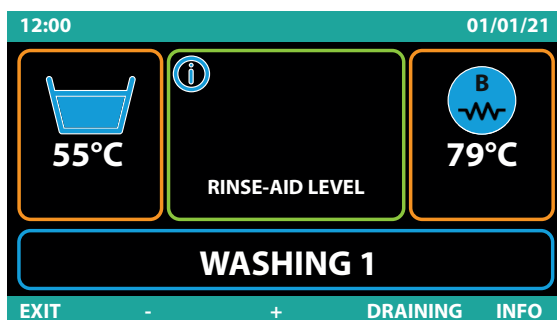

Signal screen example.



Alarms

The alarms are displayed on a dedicated screen that overlap the current display at the time the alarm occurs. Each alarm screen gives precise information about the meaning of the alarm and which are the operation the operator can run.

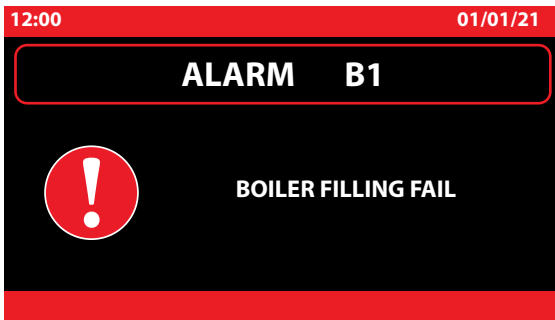

Alarm screen example.

Alarms description

TYPE OF ALARM	CAUSE	REMEDIES
B1	BOILER NOT FILLED	Open the water supply tap and verify a proper water supply flow. Contact the Rhima Service Department.
B2	BOILER SENSOR FAILURE	Contact the Rhima Service Department.
B3	BOILER NOT HEATED	Contact the Rhima Service Department.
B4	FAILURE IN RINSING	Contact the Rhima Service Department.
B5	BOILER OVERTEMPERATURE	Contact the Rhima Service Department.
B9	BOILER SAFETY THERMOSTAT	Contact the Rhima Service Department.
E1	WASH-TANK NOT FILLED	Open the water supply tap. Contact the Rhima Service Department.
E2	WASH-TANK SENSOR FAILURE	Contact the Rhima Service Department.
E3	WASH-TANK NOT HEATED	Contact the Rhima Service Department.
E5	WASH-TANK OVERTEMPERATURE	Contact the Rhima Service Department.
E6	TANK DRAINING FAILURE	Check the overflow pipe. Contact the Rhima Service Department.
E7	WASH PUMP THERMAL RELAY 1	Contact the Rhima Service Department.
E8	TANK SAFETY THERMOSTAT	Contact the Rhima Service Department.
F7	WASH PUMP THERMAL RELAY 2	Contact the Rhima Service Department.
U3	EXTRACTOR MOTOR THERMAL PROTECTION	Contact the Rhima Service Department.
Z6	TANK LOW LEVEL:	Contact the Rhima Service Department.

TROUBLESHOOTING

Type of Problem	Possible Causes	Cure
The appliance does not draw water	The water tap is closed.	Open the water tap.
	Solenoid-valve filter blocked	Contact the Rhima Service Department.
	Faulty pressure switch.	Contact the Rhima Service Department.
Flashing of the cycle lamp	See chapter Alarms .	---
Unsatisfactory washing results	The washing nozzles are clogged or the washing arms do not rotate.	Unscrew and clean the nozzles and the rotating column, refit them correctly in their seats.
	Unremoved grease or starch	Detergent concentration too low.
	Presence of foam.	Use non-foaming detergent or use less of same detergent.
	The filter is too dirty.	Remove the filter, clean it with a brush under running water and refit in its seat.
	Check tank temperature (which must be between 50°C and 60°C).	Contact the Rhima Service Department.
	Length of washing cycle inadequate for type of grime build-up.	Choose a longer cycle if possible, otherwise repeat wash cycle.
	Wash water too dirty.	Empty water from the tub, clean filters; refill the tub and correctly reposition the filters.
The objects are not properly dried.	Insufficient rinse aid.	Increase the amount of rinse aid. Contact the Rhima Service Department.
	The rack is not suitable for the objects.	Use the suitable rack which gives the objects an inclined position so that water can rinse away.
	The washed items may have been sitting in the wash chamber too long.	As soon as the cycle stops, remove the rack with the objects so that they can dry more quickly in the air.
	Rinse temperature under 80°C.	Contact the Rhima Service Department.
	Surface of objects too rough or porous for material wear.	Replace type of objects used. If the dirt on the objects is dry and old, soak before washing.
Streaks and spots on glasses and dishes	Too much rinse aid.	Decrease the amount of rinse aid. Contact the Rhima Service Department.
	The water is too hard.	Check the water hardness. Water should not be harder than 2-8 °f.
During wash cycle the machine stops and draws water	Water from the previous day has not been replaced.	Empty the tub and refill it.
	The tub water temperature is too high.	Contact the Rhima Service Department.
	Faulty pressure switch.	
Machine will not drain	Object stuck in drain pump*.	Contact the Rhima Service Department.
	Blocked drain.	Check sink's drain correctly. If not contact licenced plumber.

* If drain pump is supplied.



Australia Tel: 1300 347 944
New Zealand Tel: 0800 902 054
Singapore Tel: +65 9107 8943

DETERGENTS

To request detergents or rinse additive contact your local Rhima Service centre below:

Australia: **1300 347 944**
New Zealand: **0800 902 054**
Singapore: **+65 9107 8943**



Superwash
10 Litre
For all other washing



Final rinse
5 Litre

