

# Operator's Manual



## DVS & DVS+ Washer



# TECHNICAL SPECIFICATIONS DVS & DVS+

## A - HOT WATER

Flexible inlet hose with 3/4" G (Tube 1/2" G)  
 Min 45°C - Max 60°C  
 Water Pressure: Min 100kPa - Max 600kPa  
 18 L/min

## B - COLD WATER

Flexible inlet hose with 3/4" G (Tube 1/2" G)  
 Min 5°C - Max 15°C  
 Water Pressure: Min 100kPa - Max 600kPa  
 18L/min

## E1 - WASTE OUTLET - P TRAP (Wall connection)

Ø100mm required  
 Max discharge temp 65°C

## E2 - WASTE OUTLET - S TRAP (Floor connection)

Ø100mm required  
 Max discharge temp 65°C

## F - ISOLATOR BOX

## G - ELECTRICAL CONNECTION

240/415V AC, 3-phase + neutral, 20 AMP  
 Only room ventilation required.

## TOTAL WATER CONSUMPTION

Program 1 - 16 litres  
 Program 2 - 22 litres  
 Program 3 - 28 litres

## ELECTRIC CONSUMPTION

Program 1 - 0.18kWh  
 Program 2 - 0.19kWh



**WaterMark**

® WATERMARK LICENSE: WM-02073

This appliance incorporates back flow prevention complying with AS/NZS 3500.1. No further back flow protection is required. The installation shall be in accordance with AS/NZS 3500.1 and AS/NZS 3500.2.



**Rhima Australia Pty Ltd**  
 72-74 Woodlands Drive Bresside 3195  
 Tel: 03 8586 5444 Fax: 03 8586 5454  
[www.rhima.com.au](http://www.rhima.com.au)

**Rhima New Zealand Ltd**  
 Unit 7, 13 Beatrice Tinley Crescent  
 Albany Auckland 0632 New Zealand  
 Tel: 09 414 5575  
[www.rhima.co.nz](http://www.rhima.co.nz)

**Rhima Singapore Pte Ltd**  
 10 Tampines North Drive 4 #05-09  
 JTC Space @ Tampines North Singapore 528553  
 Tel: +65 9107 8943  
[www.rhima.sg](http://www.rhima.sg)

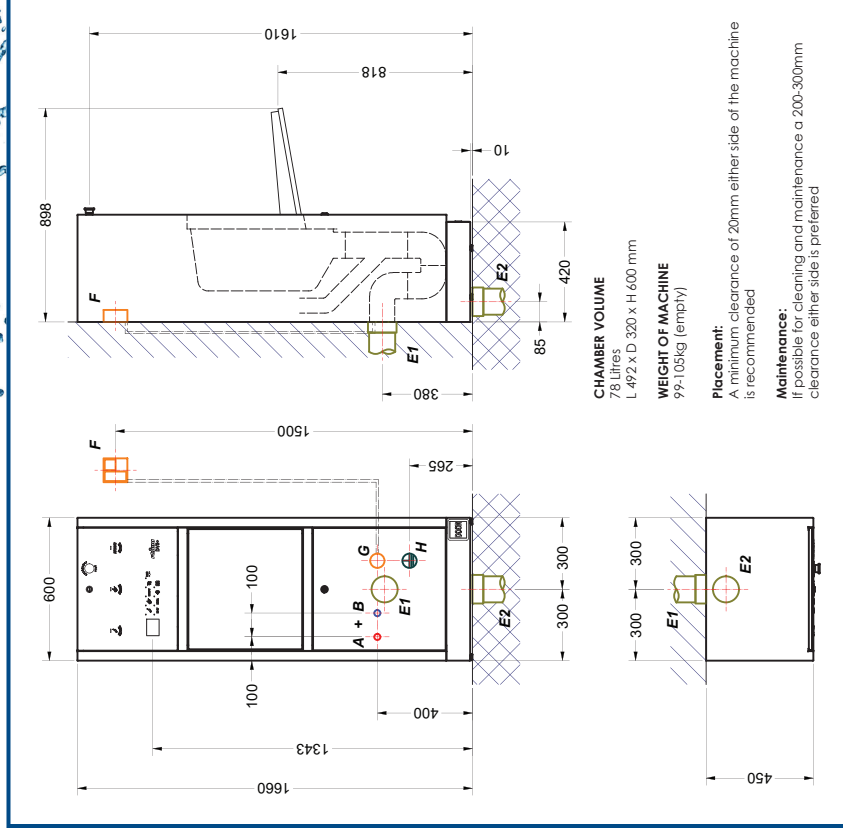

## CHAMBER VOLUME

78 Litres  
 L 492 x D 320 x H 600 mm

## WEIGHT OF MACHINE

99-105kg (empty)

## Placement:

A minimum clearance of 20mm either side of the machine is recommended

## Maintenance:

If possible for cleaning and maintenance a 200-300mm clearance either side is preferred



DVS pictured



**Rhima Australia Pty Ltd**  
 72-74 Woodlands Drive Bresside 3195  
 Tel: 03 8586 5444 Fax: 03 8586 5454  
[www.rhima.com.au](http://www.rhima.com.au)

**Rhima New Zealand Ltd**  
 Unit 7, 13 Beatrice Tinley Crescent  
 Albany Auckland 0632 New Zealand  
 Tel: 09 414 5575  
[www.rhima.co.nz](http://www.rhima.co.nz)

**Rhima Singapore Pte Ltd**  
 10 Tampines North Drive 4 #05-09  
 JTC Space @ Tampines North Singapore 528553  
 Tel: +65 9107 8943  
[www.rhima.sg](http://www.rhima.sg)



rethink  
 the way  
 you  
 clean  
**rhima**

## TRANSCRIBE THE MACHINE DATA

MODEL: \_\_\_\_\_

SERIAL NUMBER: \_\_\_\_\_

YEAR OF MANUFACTURE: \_\_\_\_\_

THIS DATA MUST ALWAYS BE QUOTED WHEN REQUESTING ASSISTANCE AND/OR SPARE PARTS TO THE MANUFACTURER.

### MODELS COVERED BY THE MANUAL:

DVS | DVS+



### WARNING

IT IS STRICTLY FORBIDDEN TO USE THE MACHINE BEFORE HAVING READ AND UNDERSTOOD THIS MANUAL.

THE MANUFACTURER DECLINES ALL AND ANY LIABILITY FOR DAMAGE DUE TO NEGLIGENCE AND FAILURE TO COMPLY WITH THIS MANUAL AND IS ALSO NOT LIABLE FOR ANY DAMAGE CAUSED BY INCORRECT INTERPRETATIONS OF THE INSTRUCTIONS CONTAINED.

CHECK FOR ANY UPDATES TO THIS MANUAL ON THE MANUFACTURER'S WEBSITE.



**Before starting to operate  
with the bedpan washer, read  
these instructions for use.**

**Original instructions  
Code 214219032 - Rev. 00  
Edit. 06-2022**

## 1 SYMBOLS USED IN THE MANUAL

Actions of particular importance or of potential risk and danger are highlighted in the manual with a symbol whose meaning is set out below.



**CAUTION!** This sign warns that if the operations described are not correctly performed, they can damage the machine.



**WARNING!** This sign warns that if the operations described are not correctly performed, they can cause serious injury, death or long-term health risks.



**HAZARD!** This sign warns that if the operations described are not correctly performed, they cause serious injury, death or long-term health risks.



**HAZARD!** This sign indicates hot surfaces. Danger of burns.



**HAZARD!** This sign indicates a potential risk of electric shock that can cause serious injury, death or long-term health risks.



**IMPORTANT NOTE!** Carefully read and memorise the information.

## 2 PRESENTATION

This user and maintenance manual is specific to the use of the bedpan washer, hereafter also called machine, suitable for cleaning sanitary containers, also called HWC (Human Waste Containers). This manual is an integral part of the bedpan washer itself, which must be kept in a safe place and known to the personnel in charge and must always accompany it when moved or resold.

The personnel in charge must be suitable and able to read and understand the contents of this manual. Furthermore, the personnel in charge must use the bedpan washer bearing in mind the accident-prevention regulations in force, the conditions of use and the bedpan washer features.

The same personnel must store it and keep it intact to allow its consultation throughout the life-span of the machine itself.

The personnel in charge must strictly and diligently follow the instructions, warnings and all indications contained in this manual.

The contents relate to normal use and maintenance operations. The manual does not include instructions for special interventions that are outside the routine use of the bedpan washer.

The removal and/or tampering with the safety devices and protections, fitted on the bedpan washer, will automatically void the warranty and liability of the

manufacturer.



**WARNING!** The manufacturer also declines any and all liability for failure to comply with the safety and prevention regulations provided by the legislation and the provisions of this manual.

If the manual is damaged or lost, a copy must be immediately requested from the manufacturer.



**WARNING!** The machine must only be installed and dismantled by personnel trained for the purpose.

There are two models of bedpan washer discussed in this manual: the Automatic model and the manual model, both with 600 mm width.

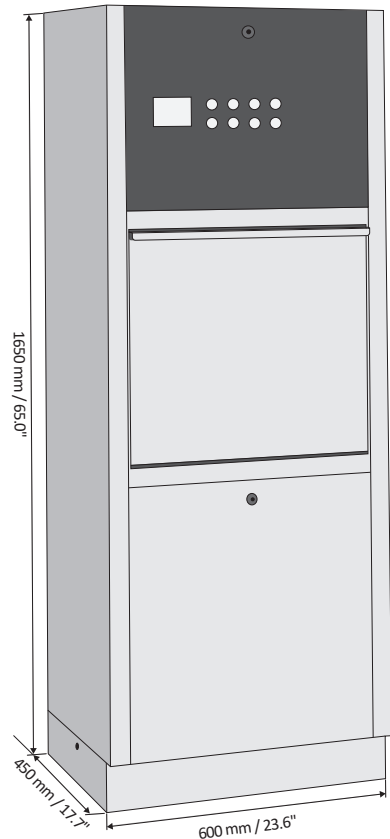



Fig. 1

This model of bedpan washer can be installed (according to the choice made during configuration):

- Stand alone
- Wall-hung
- Built-in model
- Undercounter

 **WARNING!** Failure to comply with the instructions in manual, operational negligence, incorrect use of the bedpan washer and execution of unauthorised changes, both on the machine and on the programs, are the cause of cancellation by the manufacturer of the warranty granted.

For the installation schemes see the Technical Specifications (see pg. 2).

 **IMPORTANT NOTE!** The Technical Specifications (see pg. 2) must be considered as an integral part of this user Manual.

**2.1 FIELD OF APPLICATION**

This machine, intended for washing and disinfecting, is considered a class IIa medical device (as defined by Directive 93/42/EEC class IIa). Follow the instructions of the instrument manufacturers (according to EN ISO 17664), as well as the national laws and directives for the automatic treatment of medical devices. The personnel in charge using the machine daily must be aware of its main features, and must also receive adequate and continuous training.

**2.1.1 INTENDED USE**

The bedpan washer is designed for the needs of washing and disinfecting badpans, urine bottles, commodes, urology containers, kidney-shaped basins, drainage bottles and other clinical containers used in hospital wards.

**2.1.2 INTENDED USERS**

Specialized personnel capable of working in a CSSD, Hospital's disinfection area and nurse homes.













**2.1.3 INTENDED USE OF ENVIRONMENT**

The machine is intended to be used only for internal uses. The machine is designed to be operational up to a maximum altitude of 2000 metres (6562 ft), at a temperature between 5 and 40°C (41 and 104°F) and used in an environment with a maximum humidity of 80% for temperatures up to 31°C (88°F), decreasing

linearly to 50% at 40°C (104°F).

**2.2 LABEL SPECIFICATION**

Each bedpan washer is equipped with an identification label (for the position see 8, Fig. 2). The following table shows the symbols used on the identification label:

Symbol	Description
	Manufacturer of the device.
	Date of manufacture of the device.
	Device serial number from the manufacturer.
	Model name of the device.
	Indicates the permitted temperature range (min./max.) of the water supply (steam where present).
	Flow pressure on the water inlet (steam where present) connected from min. to max.
	The user manual includes important safety information. Failure to comply with these instructions can result in injury and material damage. Please read carefully the user manual.
	For indoor use only.
	Keep away from sunlight.
	Keep dry.
	Please read this user manual carefully before commissioning the device.
	In affixing this CE mark, the manufacturer declares that this product fulfils the basic requirements of the machinery directive. The number below the mark identify the notification body.
	For the disposal of the machine please refer to chapter "Equipment Disposal".

 **IMPORTANT NOTE!** Do not cover the labels placed on the machine for any reason and replace them immediately if damaged.

### 2.3 WARRANTY

Rhima warrants the DVS/DVS+ Washer Disinfectors to be free from defects in material and workmanship under "normal use and service", which does not include normal wear and tear or preventative maintenance service. Specifically, not covered by warranty are service calls to adjust thermostats, detergent dispensers, user errors, racks and accessories, commissioning or any other service requirement not strictly related to defects in material or workmanship.

Rhima will repair or replace any parts, which in Rhima's sole judgment, are defective in material and/ or workmanship. No responsibility will be accepted for repairs, defects or damages due to improper installation, misuse or neglect. The DVS/DVS+ machines are manufactured with great care; prior to delivery they must pass an extensive quality control. If your machine shows any material or manufacturing defect, you will have a legitimate claim.

The following conditions apply and if in doubt, please refer to our general terms and conditions;

- 1) Within the warranty period we shall repair any faults with your DVS/DVS+ machine, free of charge, if caused by a material or manufacturing defect. Replaced defective parts will be returned to us and become our property. Warranty is 12 months on parts. In state capitals (within a 30 km radius of GPO) a 3-month warranty on labour, to replace defective parts, applies. All other areas are not covered by a labour warranty, unless specifically mentioned in writing. In any case, warranty repairs are only carried out within normal business hours (Monday to Friday, 08.00-17.00 hrs, excluding public holidays).
- 2) The warranty period starts on the commissioning date. The commissioning must be undertaken within 1 month of machine delivery or warranty will commence from the delivery date.
- 3) A warranty claim is not valid for defects caused by tampering or repair work carried out by unauthorized persons. This also applies to the fitting of additional accessories, which were not designed for our machines.
- 4) If a machine, which has been repaired within the warranty period, develops the same fault within 3 months after the repair, the fault will be repaired free of charge.
- 5) All warranty call outs must be approved by Rhima and have a Rhima Job number.



*IMPORTANT NOTE! The purchaser will only be able to enforce its warranty rights if it has complied with any additional conditions concerning the warranty service, also indicated in the supply contract.*

### 2.4 WARRANTY EXCLUSIONS

The following is expressly excluded from warranty claims:

- a) service or parts relating to blockages due to misuse
- b) defects to racks and accessories
- c) service or parts relating to inlet and outlet hoses
- d) adjustments to temperatures, (water) levels, detergents etc
- e) incorrect use or incorrect installation
- f) any breakdown due to external influences (high or low water temperature /pressure/ quality, interruption of electricity supply etc).
- g) all disputes arising from or in connection with these Terms shall be judged exclusively pursuant to the laws of the manufacturer's country, without giving effect to its conflicts of law's provisions. The manufacturer's nearest Court shall have exclusive jurisdiction to settle any and all disputes arising hereunder.



*IMPORTANT NOTE! This manual is the basic tool for personnel who, in various capacities, take care of the machine.*

- **USER:** The user is the person, body or company that has purchased or rented the machine and intends to use it for the intended purposes. The user must be perfectly familiar with all of command and control devices of the machine and must make sure that the personnel in charge have acquired all the information necessary for the use and routine maintenance of it. The user must also be able to perform these actions:
  - Machine commissioning and operation;
  - Loading and unloading of the material being washed on the supports;
  - Using the machine in all the different operating modes, such as the start-up of the different washing cycles provided;
  - Reset any alarms triggered;
  - Using all personal protection equipment, and complying with all adequate safety procedures, he/she should be able to carry out some routine maintenance operations, such as filling the machine with cleaning liquids and chemical additives;

- **SUPER USER:** Is the user that has special access to the device's menu for extra settings.
- **SERVICE PERSONNEL:** The person(s) in charge of installing, operating, adjusting, maintaining, cleaning, repairing and transporting the machine. Can perform every operation concerning machine positioning at the user's premises, the connection of different systems, machine commissioning, the routine and special maintenance and the repairs that require special knowledge of the machine. The service personnel is also able to recognize the dangers deriving from incorrect or improper use of the machine itself and to proceed with the final demolition of the machine.

Before proceeding with the various operations, the above listed operators, must have carefully read and become familiar with this manual.

The bedpan washer packaging, in addition to the machine's documentations, contains: the support, already inserted inside the machine with the relative document of use; the straight drain pipe to connect the siphon to the drain if wall-mounted or 2 curved drain pipes for connection to the floor; 1 tank for each chemical required; 2 keys to open the panels.

Upon delivery, check that the bedpan washer is intact and that the above-described material is actually present.

For the installation, wiring and hydraulic diagrams (water filling and draining) contact the manufacturer.

## 2.5 PRODUCT ANALYSIS

The bedpan washer was tested by applying «IEC EN 61010-1 Safety requirements for electrical equipment for measurement, control, and laboratory use Part 2-040 Particular requirements for sterilizers and washer disinfectors used to treat medical materials», where the machine is expected to:

- use with a primary voltage fluctuation up to  $\pm 10\%$  compared to the nominal voltage;
- use with a temporary type overvoltages;
  - of short duration, which may occur between the line conductor and the system earthing, which may have a voltage equal to the power supply voltage on the line-neutral +1200V, and a duration up to 5s;
  - of long duration which may occur between the line conductor and the system earthing, which may have a voltage equal to the power supply voltage on the line-neutral +250V, and a duration greater than 5s;
  - overvoltage category II;
  - pollution degree 2.
- The validation of the product was made by the manufacturer in compliance with standard ISO 15883.
- The machine does not cause harmful vibrations.

- The residual radiation emitted within the limits is non-ionizing.
- The shelf life cycle of the device is 10 years.
- The machine must not be dumped when scrapped, as it contains materials subject to legislation requiring disposal at special centres.

### 2.5.1 INLET WATER QUALITY

The quality of the water used in all stages of cleaning is important for good results.

The water used in each stage must be compatible with:

- The material which the machine is made of.
- The chemicals used in the process.
- Process requirements for the various stages of the process.

The main factors for good inlet water quality in relation to the effectiveness of washing are:

#### HARDNESS

The high hardness of the water generates a detergent inactivation, reducing its efficacy. It also causes limescale deposits in the machine, jeopardizing the cleanliness of the instruments and the machine, especially on hot parts (ex. heating elements).

#### IONIC CONTAMINANTS

A high concentration of ionic contaminants may cause corrosion of steel, manganese or copper instruments.

#### MICROBIAL CONTAMINANTS

Microbial contaminants can increase the microbial contamination of the instruments at the end of the wash.

#### The manufacturer therefore recommends that:

- the water used in the pre-rinse and washing stage should be of drinking quality according to the "Guidelines for drinking-water quality, 4th edition" published by the WHO.

Further advice should also be obtained from manufacturers of chemical and medical equipment. Where local standards are stricter than the provided recommendations, they should be followed.



*IMPORTANT NOTE! It is the user's responsibility to supply the machine with suitable water.*

---

## 2.6 TECHNICAL DATA





Description	Dimensions
Width	600 mm 23.6"
Depth with door closed	450 mm 17.7"
Height*	1650 mm 65"
Weight*	100 kg 220 lbs.
<i>*The height and weight may vary depending on the configuration.</i>	
Protection absorbed power voltage	See data plate and the Technical Specifications (see pg. 2)
Max dBA noise during wash phases	<54 dB (A)
Type of protection (according to IEC 60529)	IP20 IP: International Protection. Against ingress of solid foreign objects: $\geq 12,5$ mm diameter. Against ingress of water with harmful effects: 0 (non-protected).
CE marking	Directive on medical devices 93/42/EEC, class IIa

At the end of each cycle, a residue volume of water remains inside the machine, as specified below:

- steam generator 0.4 l (0.11 US gal.)

## 2.7 PICTOGRAMS SPECIFICATION

Each bedpan washer is equipped with hazard pictograms. The following table shows the symbols used.

Symbol	Description
	Hot parts
	Electrical shock
	Ground mass
	Equipotential

## 2.8 MAIN COMPONENTS OF THE MACHINE

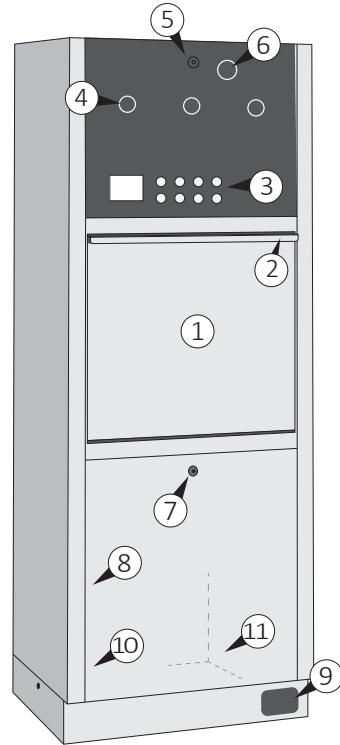

**Fig. 2**

- 1) Automatic or manual stainless steel door.
- 2) Door opening handle.
- 3) Control panel.
- 4) N.T.T. sensor.
- 5) Upper/side stainless steel panel with key lock, for maintenance and to access to the settings button. In the version with NTT, the upper panel is made of glass.
- 6) Emergency button.
- 7) Lower stainless steel panel with key lock, for maintenance.
- 8) Machine label placed behind the lower stainless steel panel.
- 9) Pedal control.
- 10) Machine label placed inside the bottom panel.
- 11) Machine label placed on the right lateral side.

## 2.9 SUPPORTS

The machine leaves the factory without any supports .



The user must requested the most suitable from the manufacturer. Figures below shows some examples of the most common use.

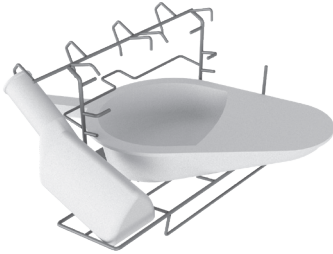

**Fig. 3a**

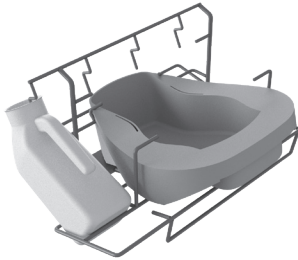

**Fig. 3b**

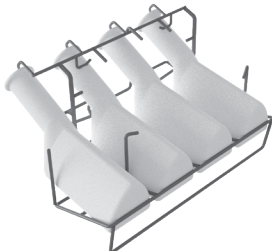

**Fig. 3c**



**Fig. 3d**



**Fig. 3e**

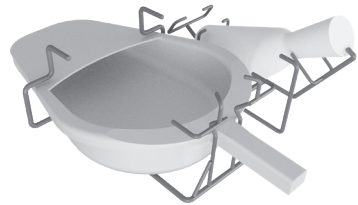

**Fig. 3f**

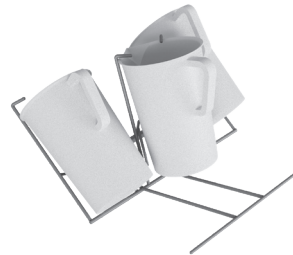

**Fig. 3g**

- 3a: holder for washing 1 bedpan and 1 urinal or 4 urinals.
- 3b: washing stand for 1 bedpan and 1 urinal or 4 urinals.
- 3c: holder for washing 1 pan and 1 urinal or 4 urinals.
- 3d: multi-washer basket for washing several large objects, e.g. jugs.
- 3e: holder for washing 2 bedpans or 2 urinal or 3 bowls.
- 3f: holder for washing 1 pan or commode and 1 urinal, rotating holder.
- 3g: holder for washing 3 2/3 litre jugs.

### 3 SAFETY AND PREVENTION

The operator in charge must be instructed on the risks deriving from accidents, on the devices prepared for the safety of the operator and on the accident-prevention rules provided by the legislation of the country of

use of the machine. When realizing the machine, all potentially dangerous situations have been foreseen and appropriate protections have been adopted. However, the level of accidents caused by careless and awkward use of the machine remains high. Distraction, carelessness and too much confidence are often cause of injuries; as well as tiredness and sleepiness. It is, therefore, mandatory to carefully read this manual, in particular section “3 Safety and prevention”.

### 3.1 GENERAL WARNINGS

#### 3.1.1 USER OBLIGATIONS

- The user undertakes to entrust the machine only to qualified and trained personnel.
- The user undertakes to set up an electric circuit breaker with an effective regulatory earthing system and the various connections for water inlet and drain.
- The user is required to take all measures to prevent unauthorized people from using the machine.
- The user undertakes to adequately inform and train its personnel on the application and observance of the safety regulations.
- Failure to comply with these rules may jeopardize the safety of the device and IMMEDIATELY void the warranty.
- The user must inform the manufacturer if defects or malfunctions of the accident-prevention system are found, as well as any presumed dangerous situation.
- Any serious incident that has occurred in relation to the device should be reported to the manufacturer and the competent authority of the Member State in which the user is established.
- The user undertakes to use only original spare parts. Otherwise, the warranty lapses. It also undertakes not to intervene for any repair work.

#### 3.1.2 INSTALLER OBLIGATIONS

- The bedpan washer must be installed and set up for use exclusively by specialised personnel and authorised by the manufacturer.
- Check that the machine has not been damaged during transport and handling.
- Use the bedpan washer only in environments that are not at risk of fire and/or explosion and in rooms at ambient temperature.
- Before installing the equipment, ensure that the supply voltage complies with the one shown on the identification plate and that the water supply pressure is equal to the one indicated in the technical data. Furthermore, make sure that the drain matches the dimensions provided on the installation drawing.
- The electrical and water connections can only be made by specialised service personnel, paying particular attention not to crush the power supply

cable and the water flexible hoses.

- Do not install the machine in the same room where patients are housed. The machine can heat the environment, thus increasing humidity.

#### 3.1.3 OPERATOR OBLIGATIONS

- Before starting to operate for the first time, become familiar with the control devices and their functions.
- The operator must not carry out operations or interventions which are not within his/her competence on their own initiative.
- It is strictly forbidden to operate or have the machine operated by anyone who has not read and understood the information in this manual, as well as by unskilled personnel who are not in good mental and physical health.
- The machine must not be operated with the guards removed or partly damaged.
- Use the bedpan washer only for the operations described in this manual.
- Do not damage or change the power cable or plug.
- Never start the machine if the cable or plug are damaged.
- Do not pull the power cable to unplug it. Always act on the plug.
- Use detergents and additives specific for manufacturer-approved washer disinfectors. Always observe the manufacturer's instructions. If, despite this, the product has negative effects on the instruments or machine, the responsibility will be of the manufacturer of the cleaning liquids.
- Only introduce instruments that can be treated with automatic cleaning and disinfection process (see manufacturer's instructions). It is particularly important to follow the manufacturer's instructions when inserting new instruments that are used for the first time.
- If additional accessories are used to load the instruments, especially hollow ones, the instructions contained in the manufacturer's instruction manual must be observed.
- Handle the chemical products with care. Chemicals for cleaning, neutralizing and rinsing contain irritants and caustic substances.
- The water in the chamber is not drinkable.
- Do not lean on the door and do not use it as a step.
- The machine during its work cycle could reach a temperature of 95°C /203°F; be very careful: there may be a risk of scalding.
- Do not change, for any reason, the characteristics of the appliance, its installation specifications and the parameters set.
- At the end of loading and unloading the instruments to be used, always close the door in order to avoid

possible unpleasant smells coming from the drain.

- In case of fire, to extinguish the flames intervene with a powder fire extinguisher, DO NOT USE WATER.
- Do not wash the machine with direct or pressure water jets, or corrosive substances.
- Do not use the machine to wash objects and/or containers that, because of their shape or material, are not compatible with the indications given by the manufacturer. For objects to be washed, please follow the instructions explicitly indicated in this manual.
- In case of long outage periods of the machine, please cut the power supply off and close the water taps.
- Do not try to open the chamber door during operation: the appliance is equipped with a special safety lock system to prevent the door from being opened.



**HAZARD!** Pay attention where indicated, for a potential danger of hot surfaces highlighted on the machine with this pictogram.

---



**HAZARD!** Pay the utmost attention where indicated, for a potential electrical hazard highlighted on the machine with this pictogram.

---

### 3.1.4 MAINTENANCE SERVICE PERSONNEL OBLIGATIONS

- Periodically check the integrity of the machine as a whole and the protection devices.
- Respect the laws in force in the country of use of the machine, in relation to the use and disposal of the products used for cleaning and maintenance. Dispose of any special waste through appropriate companies authorised for this purpose, with issue of a receipt of the successful disposal.
- The assembly of parts of other brands or any changes (in addition to voiding the warranty), can vary the machine characteristics and, therefore, compromise its operational safety.
- If the protective casings are removed, make sure that they are correctly restored before reusing the machine.
- At the end of the maintenance and repair operations, before restarting the machine, make sure that the work is completed, the safety devices reactivated and the guards reassembled.
- It is strictly forbidden to remove or tamper with the safety devices.
- The machine maintenance must only be performed with the power supply off, by qualified personnel and following the instructions in this manual.

## 4 HANDLING

Usually the packaged and palletised machine is transported to the retailer/dealer who, by means of its personnel and suitable means, in compliance with current regulations, will itself make the delivery to the end user, ensuring transport and unloading operations depending on the type of transport vehicle.

Each package, on the outside, shows the machine handling instructions in brief.

During storage or handling the contents are not sterile. Upon delivery, check that the bedpan washer is intact and that the material indicated in the delivery document is actually present. In case of damage or inaccuracies in the delivery, immediately notify the manufacturer of the extent of the damage or inconsistencies found. Should the need arise for transfers, the machine can be easily loaded on suitable equipment and on the available lifting equipment.



**HAZARD!** The loading/unloading operations can be very dangerous if not carried out with the utmost care. Therefore, before starting loading/unloading, move unauthorised persons away; clear and delimit the area where the operation takes place, and check the integrity and suitability of the lifting and transportation equipment available.

---

Also make sure that the area of operation is clear and that there is sufficient “escape space”, that is, a free and safe area, in which to move quickly in the event that the load falls. Before loading, check that there is sufficient space on the surface of the transport vehicle to accommodate the machine to be transferred.



**WARNING!** After loading the machine, secure it firmly to the surface on which it rests with taut ropes to block any possible movement.

---

After carrying out the transport and before releasing the machine from all constraints, check that the status and position cannot constitute danger.

Therefore, remove the ropes and unload using the same equipment and methods used for loading.

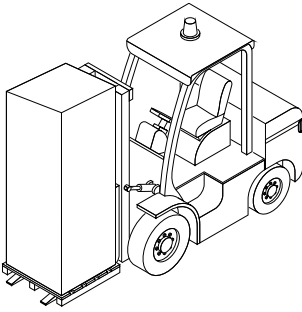

Fig. 4.1

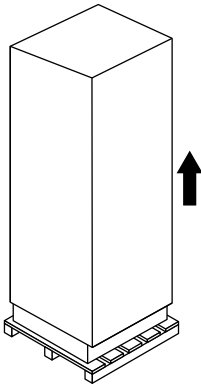

Fig. 4.2

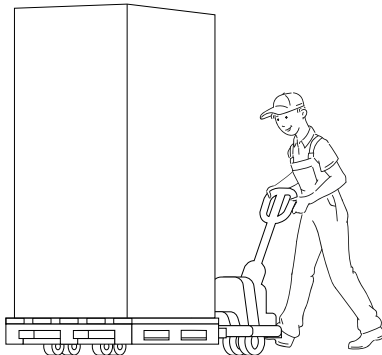

Fig. 4.3

- Handle the packaged machine only with forklift truck or pallet trucks with forks (Fig. 4.1).
- Remove the "hat" container, extracting it from the top (Fig. 4.2).
- Handle the machine with appropriate trolley. Lock the machine on the trolley with a sturdy belt (Fig. 4.3)

Do not lift the machine by grasping it from the protruding points, such as the control panel. They may be damaged or detached. With some metal components there is a danger of injury or cuts.



**WARNING!** Wear cut-resistant protective gloves during manual transport and positioning of the machine.

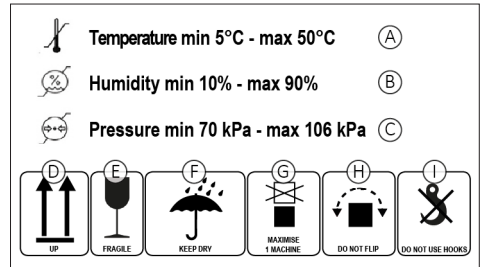

Fig. 5

A label is placed outside the packaging (Fig. 5) that indicates:

- A) Minimum and maximum temperature of the storage environment;
- B) Minimum and maximum humidity of the storage environment;
- C) Minimum and maximum pressure of the storage environment;
- D) "High" position indicators;
- E) Glass indicating "Fragile" material;
- F) Keep the packaging dry;
- G) A maximum of one machine can be stacked;
- H) Do not overturn the packaging with the machine inside;
- I) It is strictly forbidden to use hooks for handling the packaged machine.

Inside the packaging, in addition to the machine and the documentations, there are:

- the support, already inserted inside the machine with the relative document of use;
- the straight drain pipe to connect the siphon to the drain if wall-mounted or 2 curved drain pipes for connection to the floor;
- 1 tank for each chemical required;
- 2 keys to open the panels.

At the time of handover, it is essential to check immediately if all the material indicated on the documents accompanying the device has been delivered.

If the machine is to be moved, it is advisable to keep the packaging for any other relocation.

If this is not provided, dispose of the packaging materials: cardboard, polystyrene and other, separated by single material, sending them to the most appropriate final destination, which may be recovery or storage in landfills.

#### 4.1 STORAGE

If the packaged machine is temporarily stored, make sure that it is not subjected to blows and tampering. However, it must be placed in a closed, dry, dust-free environment and protected from atmospheric agents. When restored, a careful preliminary examination of its integrity by specialised personnel is necessary.

Absolutely avoid overlapping weights or foreign bodies on the packaging and the machine.

### 5 INSTALLATION

It is advisable that only furniture for professional use be positioned in the area around the machine, to avoid ruining them due to possible leakage of condensation water.



**IMPORTANT NOTE!** For a safe installation, the electrical disconnecter/plug of the device must be positioned free from any obstacle and in a visible and accessible position for the operator, so that it's easy to control it in case of emergency or prolonged safe disconnection.



**HAZARD!** Do not install and/or use the bedpan washer in environments with flammable/explosive atmosphere.



**WARNING!** Make sure that the floor, or the wall, is fit to support the load of the equipment when in operation, equal to 120 Kg /265 lb minimum.



**WARNING!** Make sure that the machine is perfectly vertical and stable, using a spirit level, if necessary.

Unevenness of the machine surface and height can be adjusted with the adjustable feet placed under the machine itself (when available).



**HAZARD!** All electrical and water connections (loading/unloading) can only be carried out by specialised and authorised personnel and by consulting the relative diagrams.

Before machine positioning make sure that:

- All the components needed for installation and proper use of the machine were installed: main switch, water supply taps, drain and anything else needed.
- These components should have all the needed features and should be installed at the locations shown in the installation scheme.



**WARNING!** The use of unsuitable parts, and/or the implementation of installation procedures other than those shown in the Technical Specifications (see pg. 2), will immediately void the machine warranty.

- The characteristics of the electricity network must be compatible with the values required for correct operation indicated on the machine identification plate and on the technical data sheet.
- The machine must be connected to an efficient earthing system (according to electrical safety standards).



**IMPORTANT NOTE!** The manufacturer is not to be held liable for any damage caused by improper grounding of the machine or faulty power supply.

### 5.1 ELECTRICAL CONNECTION



**HAZARD!** Only qualified and experienced personnel can connect the machine to the mains supply, in compliance with the current laws and regulations.



**WARNING!** In the single-phase version, the main switch of the power supply line must be a multi-pole circuit breaker, with adequate residual current protection.



**WARNING!** In the three-phase version, the main switch must be multi-pole circuit breaker, with adequate residual current protection, positioned near the machine and not covered by machines or other that may hinder its use.

- The magnetic-snap safety system of the fuses must be calibrated according to the power indicated on the machine plate.
- Make sure that the measured voltage is equal to the one reported on the identification plate of the machine;
- Check that the voltage does not differ by more than 10% from its rated value;
- Make sure that the electrical system is equipped with an efficient grounding connection;
- Connect the cable that comes out of the machine to the wall socket. In case the machine has a three-phase connection (standard), connect the cable installed on the machine to the three-phase plug and insert it into the interlocked socket next to the machine (not provided).
- The socket must be accessible after the machine installation. This facilitates verification of the electrical safety, e.g. in repair or maintenance interventions.
- The machine must be supplied with current whose voltage, frequency and protection values correspond to those indicated on the data plate.
- Additional indications regarding the electrical connection are shown in the Technical Specifications (see pg. 2).



**IMPORTANT NOTE!** The fuses must be in compliance with Standards IEC 60127-2, UL248-14, CSA C22.2.



**HAZARD!** Make a permanent connection with the power supply in order to reduce any danger for the users.

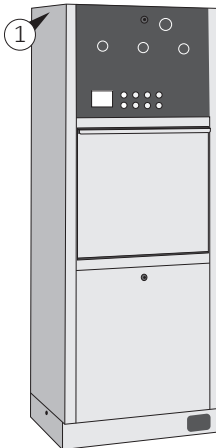

**Fig. 6**



**HAZARD!** Damaged fuses must be replaced (see Fig. 6) by authorised personnel (for the value and size of the fuses see Annex 10.8).

### 5.1.1 ELECTRICAL CONNECTION

Connection of the machine to the electrical mains must be made by qualified, skilled personnel.



**WARNING!** Power supply cable: it is compulsory for the retailer - installer to adapt the insulation class of the power supply cable to suit the working environment in compliance with current technical regulations.

- Check that the electric specifications match those shown in the label.
- The electrical connection must be carried out in compliance with current technical regulations.
- Make sure that the primary voltage reading corresponds to the voltage indicated on the machine plate.
- Check that the power supply voltage does not differ by more than 10% from its nominal value.
- The frequency of the power supply voltage must not differ by more than 1% of its value.
- Connection of the machine to the mains must be provided with an earth connection and an equipotential circuit as set forth by current standards.
- Make sure that the electrical systems are efficiently earthed.
- The earth conductor is to be connected to the earth terminal identified by the standard symbol.
- The machine is equipped with a terminal identified by the relative symbol for equipotential connections between appliances (see rules for electrical plants).
- Connect the machine by using the power cable supplied with the machine.
- In case of prolonged use of the machine it is recommended that you execute the disconnection procedure of the electrical connection by placing the dedicated safety device in "OFF" state.
- The upstream electrical power line must be dimensioned and protected in accordance with current local regulations.

### Electromagnetic compatibility (EMC)

The machine has been tested on electromagnetic compatibility pursuant to Standards EN 61326-1 and is suitable for operation in institutes such as hospitals,

laboratories, medical practices and environments connected to the public electricity grid.

The high-frequency (HF) energy emissions of the machine are so small that interferences with electrotechnical equipment in the immediate vicinity are not likely.

The optimal positioning floor must be made of concrete, wood or ceramic tiles. In case of machine operation on floors made of synthetic materials, the relative humidity must be 30% to minimise the likelihood of electrostatic discharges.

## 5.2 WATER CONNECTION



**CAUTION!** The water in the wash chamber is not drinkable.

The quality of the water used must be compatible with the manufacturing materials of the machine, with the chemicals and with the process needs in the various stages of the procedure.

To have good washing results, the water must be soft and low in limestone. With hard water white patinas deposit on the objects to be treated and on the walls of the wash chamber.

For the correct operation of the machine, the water inside the washing chamber must have a maximum hardness of 3.03 mmol/l CaCO<sub>3</sub> (17.80°DH / 30°fH). If the installation site does not have water with the required specification, it is necessary to install an external softener.

The water used in all the washing stages should be of drinking quality according to the “Guidelines for drinking-water quality, 4th edition” published by the WHO. A high iron content can cause rust on the load and in the special washing machine. If industrial water contains a higher amount of chlorides than 100 mg/l, the risk of corrosion significantly increases.

Water hardness conversion table:

French degrees [°fH]	CaCO <sub>3</sub> [mmol/l]	German degrees [°DH]	CaCO <sub>3</sub> [PPM]
0-10	0-1.01	0-5.60	0-100
11-15	111-1.51	6.16-8.40	110-150
16-20	1.61-2.02	8.96-11.20	160-200
21-25	2.12-2.52	11.76-14.00	210-250
26-30	2.62-3.03	14.56-17.80	260-300
31-35	0-5.60	17.36-19.60	310-350
36-40	6.16-8.40	20.16-22.40	360-400
41-45	8.96-11.20	22.96-25.20	410-450

French degrees [°fH]	CaCO <sub>3</sub> [mmol/l]	German degrees [°DH]	CaCO <sub>3</sub> [PPM]
46-50	11.76-14.00	25.76-28.00	460-500
51-55	14.56-17.80	28.56-30.80	510-550
56-60	5.66-6.06	31.36-33.60	560-600

The special washing and disinfecting machine is standard prepared for connection to cold and hot water. Connect the flow pipes to the shut-off valves for cold and hot water.

- The machine must be connected to the water mains in accordance with current regulations.
- If the water supply of the device has not been used for a long time, or if it is used for the first time, purge it by draining the water into a container or into a drain for a few minutes in order to remove any impurities, air bubbles and/or whatever may damage the machine and clog its filters.

	Cold water	Hot water
Min. temperature	5°C 41°F	45°C 113°F
Max. temperature	20°C 68°F	60°C 140°F
Recommended flow pressure	300 kPa 43 PSIG	300 kPa 43 PSIG
Min. flow pressure	170 kPa 25 PSIG	170 kPa 25 PSIG
Max. flow pressure	600 kPa 87 PSIG	600 kPa 87 PSIG

- Connect the cold and hot water hoses exiting the machine with their respective network connections, as shown on the Technical Specifications (see pg. 2). It will be the responsibility of the installer to make sure that the temperature of the cold water supply is correct, otherwise proper washing of materials cannot be ensured. The connections for cold and hot water must not feed any equipment other than the bedpan washer. During the washing cycle, this is necessary to prevent the subdivision of the water supply with other users, thus leading to a substantial increase in the time required to fill the chamber (in this case an alarm will be triggered to alert the user that the maximum time allowed for water loading is exceeded).
- Connect the flexible hoses to the machine valves positioned in view at the back, making sure to connect them correctly based on the sales configuration.
- Make sure to connect the water flexible hoses in the positions shown in Fig. 7.

- Connect the water flexible hose to connections shown in Fig. 7.



**HAZARD!** Be careful in case of a blockage of the drain which could cause spill out of water and the risk of slippery floor.

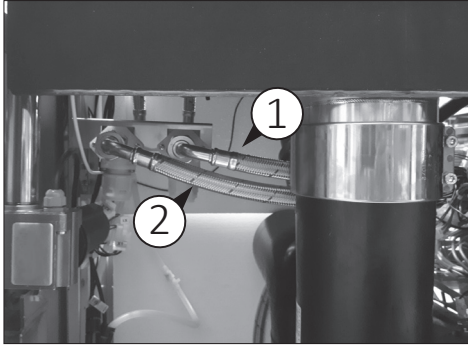

**Fig. 7**

### Water connections (Fig. 7)

- 12) Cold water connection.
- 13) Hot water connection.



**WARNING!** The flow pipes must not be shortened or damaged.

The water supply taps must be capable of quickly stopping the water line, therefore, they must be equipped with a ball or a gate valve. They must also withstand the operating pressure of the water, as indicated in the technical data sheet.

Proper placement of the taps is shown on the Technical Specifications (see pg. 2).

### 5.3 CONNECTION OF THE DRAIN TRAP

The machine is equipped with a built-in drain trap which must be mandatorily connected to the drain system of the building.

The drain pipeline can be on the floor or on the wall according to the solution decided during purchasing.

The user must carry out periodic maintenance of the drains and check that they are not clogged.

Before connection:

- supply the water connections with separate shut off valves;
- flush out the water pipes that are to be connected to the machine, to prevent clogging of filters and valves;

Procedure:

- 1) Connect the machine to water connections (Fig. 7).
- 2) Connect the bottom drain pipe to the drain connection located at the bottom of the machine.

The correct positioning and sizing of the drain trap are shown on the installation drawing (see the Technical Specifications (see pg. 2)).



**WARNING!** The bedpan washer drain pipe must be maintained if backflow and other drainage issues are to be avoided. Be careful not to crush the pipe. If the pipe has been crushed, kinked, or otherwise damaged, consider replacing it to prevent future drainage issues.

Foreseeable misuse:

The machine should not be used:

- for disposal of materials harmful to wastewater, e.g.: drugs, solvents, paints, etc.
- for disposal of materials such as napkins, sanitary napkins, etc.
- for disposal of food, e.g. salad or vegetables
- for use as a toilet

#### 5.3.1 DRAIN CONNECTION

The drain connection must be properly installed according to the applicable instructions.

Bedpan washers are equipped with a Drain Control System (D.C.S.), a safety device that stops all machine functions if the drain trap is clogged. This prevents the machine from being used until the breakdown situation has been eliminated.



**HAZARD!** If the drain connection is installed incorrectly, the drain water could flow backwards into the machine's chamber.



**IMPORTANT NOTE!** The manufacturer is not liable in case of environmental pollution due to an incorrect use of the bedpan washer.

### 5.4 CHEMICALS

The bedpan washer adopts as standard 1 pump for limescale remover. On request it can have up to a maximum of 2 dosing pumps for:

- Detergent agent;
- Limescale remover.

Each dosing pump is monitored by a flowmeter. This electronic control checks the dosing amount.



In the event of a lack of product, a message appears on the display and the program stops.

---

 **WARNING!** *It is recommended to handle the liquids with caution.*

---

- Protect eyes, hands, clothes and metal surface from contact with liquids, which contain partially irritating agents and caustic substances.
- In case of contact with liquids, consult the instructions provided with the product.
- Use only suitable liquids for cleaning equipment. Carefully follow the manufacturer's information.
- Keep chemicals out of the reach of children and outsiders. Possibly locked away.
- Use on only the manufacturer's approved products.
- Do not use liquids for household dishwashers.

**5.4.1 REFILL PROCEDURE**

- 1) Set up a new tank with the chemical.
- 2) Remove the suction lance from the exhausted tank.
- 3) Insert the suction lance in the new tank.

Be careful not to reverse the position of the liquids.

---

 **WARNING!** *Failure to follow these recommendations may damage the bedpan washer.*

---

- With regard to the maximum dosage for each program, follow the instructions of the chemical manufacturer.
- To ensure efficiency of the dosing system, it is necessary to regularly carry out the maintenance operations set out in the chapter "Maintenance".
- The indications concerning the storage and disposal of chemical substances are provided by the respective manufacturers and must be observed.
- Do not place the chemical containers on the machine. Completely empty the bedpan washer before performing maintenance and before moving the machine to avoid contact with the chemicals and to protect the machine components.

**5.4.2 USING AND STORING CHEMICALS**

Keep the containers tightly closed, stored in a dry place and protected from the sun, out of reach of children and outsiders. Possibly locked away. Optimal storage temperature: check the chemicals datasheet. The shelf life in the original containers is indicated on the chemicals' labels. The manufacturer recommends a method for inventory management (first in- first out).

The washer disinfectant can use up to 2 products for dosing liquids.

The manufacturer recommends using cleaning agents and chemical additives. The use of other products can damage the machine.

The flow meters of chemicals are calibrated according to the density of these tested products which ensure correct operation.

The following combinations of process fluids have been tested to verify the compatibility of the materials with the components inside the device. When chemical levels are low, a warning message appears on the display.

Chemical products dosing is set to an average value as recommended by the manufacturer.

When the actual dosing of the chemical exceeds the tolerance of 5%, the system goes into alarm.

---

 **WARNING!** *Use only the chemical products recommended by the manufacturer, tested and validated in accordance with ISO EN 15883. The use of non-certified products will void the warranty.*

---

The machine leaves the factory with the washing programs set for the use of the following validated chemical products:

**Supplier: RHIMA**

**Detergent** Rhima Mediwash

**Limescale remover\*** Rhima Descale

*\*Optional.*

---

 **WARNING!** *If the machine does not use the liquids chosen in the machine configuration, the flow meters must be recalibrated for the new liquids.*

---



---

 **WARNING!** *If the machine uses two canisters, be careful not to swap the suction lances when replacing the exhausted canisters: always read the label near the canister cap and the label on the liquid canister.*

---

The limescale remover is calibrated to a water hardness of up to 30°fH /16.8°DH.

**6 DESCRIPTION OF THE APPLIANCE**

Machine for wash and disinfection of urinals, commodes, urology containers, kidney-shaped basins,

drainage bottles and other human waste containers.

The device, using washing jets inside the washing chamber, can thoroughly empty and wash the above indicated products. After washing, a disinfection is performed introducing high temperature steam. All these procedures are performed according to suitable wash programs and following the instructions indicated in the "Machine wash programs" paragraph.

Electricity is used to power the appliance and can also be used to generate steam when the machine has a built-in steam generator.

Containers are emptied automatically when the door is closed. The material in the containers is dumped into the wash chamber and passes through the drain trap to go to the sewer system.

Washing is done using water coming directly from the hot and cold water mains, with an anti-backflow system according to EN 1717 Standards. Be advised that wash programs are not influenced by variations in water mains pressure as the machine has its own water storage tank and a wash pump that takes the needed water from this tank.

Disinfection is done introducing steam directly into the wash basin. This steam can be generated either by a special boiler called "steam generator" (if the machine is equipped with this system), or can be taken directly from a local steam pipeline network (if the building has a steam pipeline network). In order for containers introduced into the wash basin to be disinfected, the temperature in the chamber must be kept above a preset value (minimum 85°C/185°F) for a time period of at least one minute.

The items to wash and disinfect are inserted on special supports.

Every wash program of the device is totally automatic. Once the wash cycle is started, the operator is free to perform other tasks until the cycle is finished.

The validation process must be performed by the final user, using the dirt, stated in the current regulations.

## 6.1 CONFIGURATIONS

### 6.1.1 DISINFECTING SYSTEMS

The machine can be equipped with two different disinfecting systems:

#### Thermal disinfection with steam generator

During each wash cycle, a small boiler heat water to generate steam using a heating coil. The device software takes care of setting the disinfection temperature and its duration.

All 15883 machines, when not used for 24 hours, automatically start a disinfection cycle, composed by

some wash phases, a disinfection phase and a final rinse with sanitized water (hotter than 65°C/149°F).

The door should always be closed when not working for long periods of time, or, even better, after every wash cycle, both for automatic and manual door.

#### Thermal disinfection with steam pipeline network connection

Steam is taken directly from the local steam pipeline network. Flow is regulated by a solenoid valve that allows or prevents steam entrance into the basin to perform the disinfection.

### 6.1.2 SAFETY THERMOSTAT

The machine model with steam generator, (meaning with self-generated steam) is equipped with a safety thermostat that interrupts power to the steam generator heating coils when the temperature of the heating coils exceeds a certain limit. Exceeding this limit could cause damage to the heating elements. To restart the appliance you must eliminate the causes (the display will show the error message: "E40: Overheating").

### 6.1.3 AUTOMATIC DOOR

Door opening and closing is commanded by an electric system actuated by a pedal-controlled switch and/or by an infrared sensor. Touching the button for the desired wash program causes the door to close and after a few seconds, the wash cycle to start. A safety device prevents the door from reopening before the wash cycle is terminated. If during closing, the door encounters any obstacle on its way, then it will partially reopen to prevent damage to the person or object on its way. If movement is blocked when the door is opening then the door stops. The red push-button instantaneously stops any machine function (including door movement) in case of an emergency. To reset machine operation just release the emergency push-button, rotating it in the direction of the arrow.

Door opening at the end of the wash cycle is also be automatic. This speeds up drying of the products being washed and also informs the operator that the wash cycle is terminated: the operator can see that the appliance has terminated its work cycle and is ready to start a new cycle.



**WARNING!** *The red emergency push-button blocks machine functions, it DOES NOT interrupt electrical power. To interrupt electrical power turn off the service switch or the main switch.*

---

### 6.1.4 N.T.T. (NO TOUCH TECHNOLOGY)

Wash programs can be started using three no touch sensors as well as using the standard control panel. The symbol on the sensor is the same as the symbol on the control panel and indicates, for both functions, the related kind of program.

An infrared sensor performs the same function as the pedal control: it can be used to open and close the wash chamber door.

Use of no touch sensor on machine is part of the cleanliness and hygiene philosophy that the company has been pursuing for years, making it easier and cleaner for operators to use the machine. Generally the items to be washed are carried to and placed in the machine using disposable gloves. These gloves might get dirty during these tasks. The no touch sensor permit the wash cycle to start without the need for the operator to remove the gloves.



**Fig. 8**

The sequence we recommend for properly using the appliance is as follows:

- 1) Once in front of the machine with the items to be washed, use the pedal control to open the door;
- 2) Place the items on the support as indicated in the support's instructions;
- 3) Start the chosen wash cycle by passing your hand in front of the sensor;
- 4) When the wash cycle is finished the machine will open automatically the door;
- 5) Remove the items that have been cleaned;
- 6) Close the door activating the infrared sensor or the pedal.

## 7 USING THE MACHINE

Before starting the machine, the operator in charge must have read and understood this whole manual, in particular the information given in section «3 Safety and prevention».

Furthermore, before starting work, check that the machine is in order and that all parts subject to wear and deterioration are fully efficient.

### 7.1 COMMISSIONING INSTRUCTIONS

These control operations (reported below) are performed to check if the machine works properly and should be performed when the machine installation is completed.

- 1) Open the tap that supplies water to the machine.



**WARNING!** *The water should NOT flow into the chamber; otherwise the water loading solenoid valves are dirty or blocked due to long storage in the warehouse and therefore they must be cleaned.*



**WARNING!** *Check that there are no water leaks in the pipe fittings.*

- 2) Check that the suction tubes (located in the lower part of the machine) within the corresponding tanks containing the liquids provided (limescale remover and detergent), are correctly inserted.
- 3) Using the main circuit breaker, supply power to the machine.
- 4) Check that the water supply flexible hoses are properly connected.
- 5) At the beginning of the first cycle check the level probes of the liquid suction tubes (limescale remover and detergent): pull one tube at a time out of the container and check if the corresponding alarm flashes on the display, indicating the need for liquid refilling.
- 6) Check if the peristaltic pumps correctly suck washing liquids. To do this, check that the liquid rises along the tube connected to them.
- 7) If a machine with automatic door has been installed, open the door and slightly grease the three sides of the basin seal (that may have dried due to a long warehouse storage) and the corresponding door parts on which the seal will lean when the door is shut. Open and close the door a dozen times, helping the travel by applying a slight force with both hands at the two sides of the door.

### 7.2 BEFORE USE

The bedpan washer can be used for cleaning and disinfecting:

- urinals;
- commodes;
- urology containers;
- kidney-shaped basins;

- drainage bottles;
- other human waste containers.

### 7.2.1 PREPARING THE LOAD

The machine is usually provided with a standard support. This support can be used to wash most of the urinals used in hospital wards. The manufacturer can provide, on request, other supports that can be interchanged with the standard one and can be used to wash bowls, large bottles with a wide variety of shapes. The instructions for these supports are provided with the support itself.

It is good practice to always check that the containers introduced in the wash chamber are suitable for the kind of support that you have. To do this, make sure that the items introduced are firm enough on their support, so that they remain in their housing without changing position when the door is closed.

Each country uses its own types of container, often with different physical characteristics. As a consequence not all types of support may be suited for washing your containers.

The system of supports allows the machine to automatically empty, wash and disinfect the human waste containers.

Each support has instructions regarding the specific use for which it is designed. These instructions are attached to the documents provided with the machine or to the support itself.



**IMPORTANT NOTE!** *The cleaning quality depends on the correct loading of the instruments.*

After loading the items to be washed (as described in the instructions given with the support) the machine's wash cycle can be started, selecting on the control panel the program that best suits the items that have been introduced into the appliance.



**WARNING!** *Make sure that the max load inserted inside the washing rack does not exceed 5 kg/11 lbs. Higher loads could damage the door closing mechanism.*

## 7.3 PROGRAMS

The machine leaves the factory with presetting washing programs already entered in the settings menu.

*For programs details see the Washing Programs booklet.*

To operate the machine just select the program on the control panel touching the key related to the desired cycle: normal, short, intensive or the special ones. The device will automatically lock the door and start the selected cycle. In case of failure the machine stops automatically and the display shows the cause that interrupted the wash cycle.

Once the wash cycle is terminated just open the door and remove the material that has been washed.



**WARNING!** *A safety device prevents the door from being opened until the temperature inside the basin and the temperature inside the steam generator are lower than the temperature of 88°C.*

### 7.3.1 PROGRAM STRUCTURE

- Pre-wash: One or more wash steps with cold water to remove most of the dirt
- Wash: One or more wash steps with hot water for cleaning action.
- Disinfection: Disinfection with self-produced steam and injected through the wash jets. During the phase the value  $A_0$  is calculated in real time.
- Final rinse: Final rinse with disinfected water to remove most of the residual steam.
- Cooling: To cool the washing chamber before opening.

## 7.4 STARTING THE MACHINE

After checking the integrity and full efficiency of the machine, proceed with start-up:

- Power on the machine using the main circuit breaker.
- Turn on the service switch.
- Open the door.
- Load the instruments on the support.

To access the service switch (Fig. 9) you must remove the lower or side panel (depending on model), using the provided key.

This switch must be turned on to supply electrical power to the appliance (ON = start-up position "1"; OFF = shutdown position "0").

The display will turn on and the machine will be ready to be used after few seconds.



Fig. 9

#### 7.4.1 BEFORE STARTING THE PROGRAM

Before starting each program, check that:

- Products must be arranged correctly.
- Liquid containers must be sufficiently filled. Check for any messages on the display before starting the program.

#### Closing the door

- Close the door until the lock is activated. The door can be unlocked and opened at any time before the program starts..

#### Selecting the program

To select the programs available, use keys on the control panel, depending on the most suitable program for the level of dirt and type of the load.



**WARNING!** Remove dirty rubber gloves before pushing the program button to prevent the problem of cross infection.

#### 7.4.2 STARTING THE PROGRAM



**WARNING!** Always follow the indicated procedures. Inattentive and frivolous use of electrical devices may lead to risks for the operator.

The manufacturer is not liable for possible damage caused by uncontrolled use of the device.

After selecting the program with relative key, the display shows the selected program and the operating time and temperature.

Time counter use the first cycle to self calculate the time for each cycle.

#### Program execution

Once the program has started, its progress can be followed on the display. The display shows the program phases during operations.



**WARNING!** The program can be interrupted at any time. However, it must be remembered that once interrupted, it must restart from the beginning.



**HAZARD!** In case of contact with the fluids inside the chamber, immediately contact the nearest health center.

- Pre-wash: The pre-washing phase is performed using cold water, to remove most of the dirt.
- Wash: The washing phases are performed using the hot water to improve the washing results. During the hot washing phases it is possible to add the detergent liquid (optional) to help the washing.
- Disinfection: At the beginning of disinfection the water tank is filled at low level with hot water and softener liquid (standard). The machine is preparing the final rinse, in the mean time the steam generator is heating the water up to 100°C/212°F and produces steam. Steam flows out of the steam generator and passes through the same pipes used for washing, until it reaches the chamber. A temperature of 85°C/185°F is reached and maintained for 1 minute inside the chamber. Both the time and the temperature of the disinfection phase are customizable.
- Final rinsing: The hot water with softener liquid, at around 45°C/113°F, enters in the steam generator and mixes with hot water remained after the disinfection at 100°C/212°F. The result is a water hotter than 65°C/165°F (disinfected water) that is used for the final rinse. The other important point is the softener in the water, that has a double function:
  - Clean the steam generator and chamber from scale residues.
  - Dry the bedpan, thanks to its surfactant properties.
- Cooling: The bedpan washer door remains locked until the chamber reaches a temperature below 75°C/167°F. The machine is therefore designed with a standard and an optional cooling systems:
  - D.W.C. (Disinfected Water Cooling - standard): Automated system for prompt disinfection of the water used in the final rinse to lower the washing chamber temperature before being flushed. A.C.S. (Air Cooling System- optional): Cold air is introduced by a fan in the washing chamber, through the drain, to lower the internal temperature and partially dry the disinfected containers. By condensing the

excess steam, it prevents the aerosol effect for the operator and the thermodynamic contamination of the room. Inside the drain (overflow pipe) there is a condenser to prevent the exit of steam from the back side of the machine.



**HAZARD!** It is the responsibility of the user to dry the instruments that have just been washed, using suitable cloths and following the instructions contained in the instruction manual for each individual instruments washed.



**HAZARD!** The instruments must NOT be left inside the machine, at the end of the cycle, wet, for longer than 5 minutes. This is to prevent the proliferation of bacteria and microorganisms. The manufacturer declines any liability for contamination of the instruments during the manual drying stage.

#### 7.4.3 PROGRAM END

The message «Cycle end» on the display indicates that the program has been carried out correctly.

Bedpan washers are equipped with a buzzer, triggered for a few seconds at the end of the wash cycles to indicate that the machine has terminated its program. This buzzer can be disabled if needed.



**IMPORTANT NOTE!** Open the door immediately after the end of the program to avoid condensation forming.

Open the door (with rubber gloves on) and check the results at the end of the cleaning process. The instruments must be completely clean.

The machine is equipped with an Empty Total System (E.T.S.): at the end of each cycle, water is automatically drained from the water pump, water storage tank and pipes in order to ensure freedom from microbial contamination inside the machine.

#### 7.4.4 EXTRACTING THE LOAD

At the end of the program and when extracting the load do not force the door open to avoid damaging the device or creating a hazardous condition.



**WARNING!** Remember not to use dirty gloves once the door is open and before extracting the load.



**WARNING!** Particularly large instruments can be very hot at the end of the program. Allow instruments to cool down before removing them. Use adequate gloves that protects against burns.



**WARNING!** Failure to follow these recommendations can cause burns.

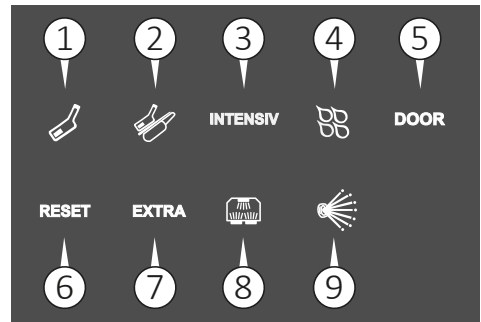

## 8 CONTROL PANEL

The control panel consists of 9 keys (some optional) and a 3.5 inch LCD display. Some keys are multi-function, depending on the action being performed in a specified state of the device.



**Fig. 10**

Here below the description of the control panel. Later on, with the description of how the machine works, we will find these symbols again.

Button	Description
	<b>URINALS WASH program key</b> Cleaning and disinfection of slightly soiled care HWC, such as urine bottles.
	<b>NORMAL WASH program key</b> Cleaning and disinfection of soiled care HWC.
<b>INTENSIV</b>	<b>INTENSIVE WASH program key</b> Cleaning and disinfection of heavily soiled care HWC.
	<b>SLOPSINK WASH program key</b> Cleaning the separate slopsink.
<b>RESET</b>	<b>RESET key</b> Restoring the alarms.

Button	Description
<b>EXTRA</b>	<b>EXTRA program key (optional)</b> User customized special program.

#### **MULTIWASHER program key (optional)**

This program is specific for a multi-purpose basket. It consists in a basket with two rotating spray arms to decontaminate general items in hospitals, clinics and such. The multiwasher basket is suitable for any kind of accessory or container that does not have to be reprocessed in the sterilization department.

Using the multiwasher basket is very simple: the user just need to remove the support from the inner door of the washer and insert the basket, laying it on the handles on the walls of the washing chamber. The water inlet of the basket will fit inside the dedicated hole in the washing chamber. The user now will only have to press the specific button program..

#### **HDS program key (optional)**

This key can be used in two different way:

If pressed lonely, the HDS program starts: it consists of a special nozzle inside the washing chamber that sprays pure detergent on the human waste container (for 5 seconds), letting it react for a certain amount of time (30 seconds), before a rinse phase. This spraying/rinsing phase is repeated for a defined amount of times (5 default). It is also possible to custom all these parameters (time of the spraying, time of the reaction, number of repetitions) as desired. If pressed before selecting a program, a solvent liquid is sprayed on the human waste containers, to eliminate zinc emulsion residuals, letting it react for a certain amount of time (30 seconds), before start the selected program.

## 8.1 DISPLAY

The LCD display makes it easier to use the appliance, giving a great deal of information regarding the state of the components inside the machine and showing the status of the running program. The temperatures are set in degrees Celsius or Fahrenheit. The images are animated, to show how the current operation evolves. The display also shows all the warning and alarm messages necessary to correctly use the device plus descriptions of how to solve the alarms.

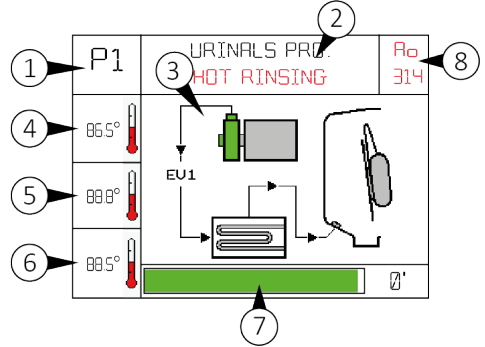

**Fig. 11**

#### **Description of the display (Fig. 11):**

- 1) The number of the running program is displayed (e.g. P1 = Short program);
- 2) It displays the name of the program and the phase that the machine is running;
- 3) Several images showing the current status of the machine are displayed;
- 4) It displays the temperature measured by the first PT1000 probe placed in the chamber;
- 5) It displays the temperature measured by the second PT1000 probe placed in the chamber. The temperature detectable by the two probes must not differ from each other by more than 2°C (36°F);
- 6) It displays the temperature measured by the third PT1000 probe placed in the chamber. This Disinfection Validation System (D.V.S.) is optional and ensures that the temperature inside the chamber is correct if one of the two main probes fails.
- 7) Bar indicating the progress of the program; if the program is ending, the bar will be almost entirely green;
- 8) The A<sub>0</sub> value is displayed during disinfection;

#### **8.1.1 DISPLAY SCREENS**

After starting the machine, following the instructions in chapter "Starting the Machine", the display will show

the images indicating step-by-step the operations in progress.

- 1) Once the machine has started, the screen for selecting the programs will appear. Place the human waste containers to be washed in the support and close the door (if the machine is automatic, the door closes automatically once the program is selected). Then press the selected key on the control panel to start the program.

➔ **IMPORTANT NOTE!** The door must be tightly closed until you hear the classic closing «click», otherwise the program will not start.

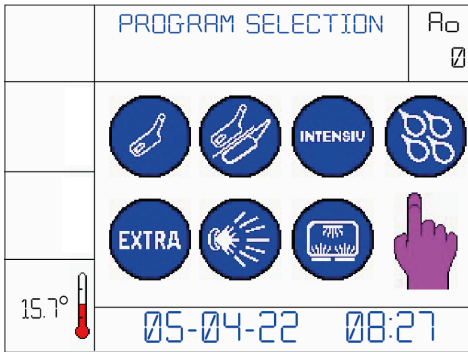

Fig. 12.1

**8.1.2 PROGRAM 1 URINALS**

**Phase 1**

- 2) The machine starts the automatic working cycles. It discharges the residues present in the items and starts the first rinse with cold water.

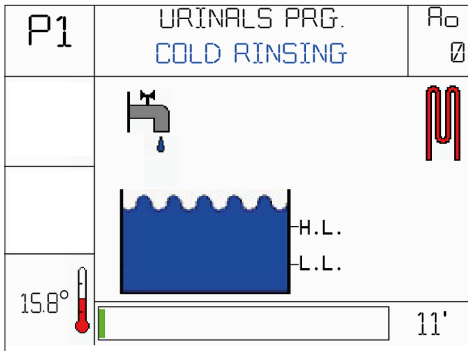

Fig. 12.2

- 3) The display shows the solenoid valves that are operated in the different phases. EV5 is used for rinsing with cold water. The water is automatically

discharged.

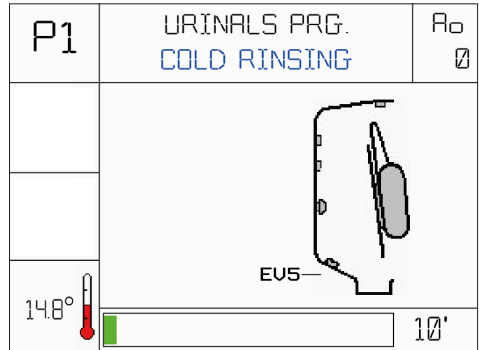

Fig. 12.3

**Phase 2**

- 4) The machine fills the tank with hot water and adds detergent (if any).

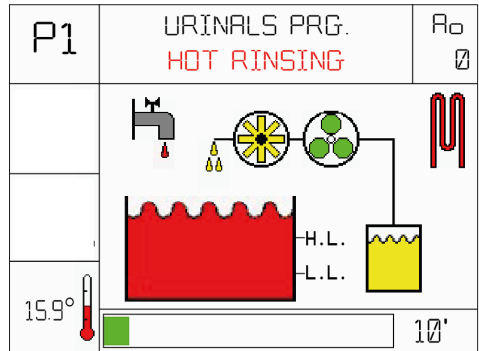

Fig. 12.4

- 5) The hot water is sprayed into the chamber through the EV5 solenoid valve. The water is automatically discharged.

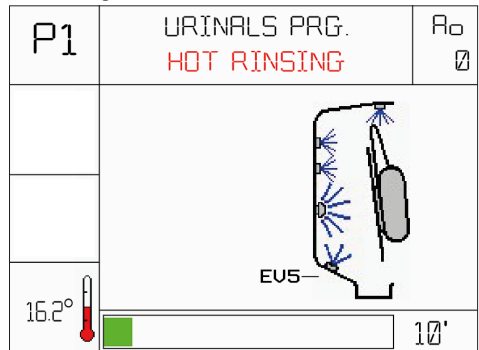
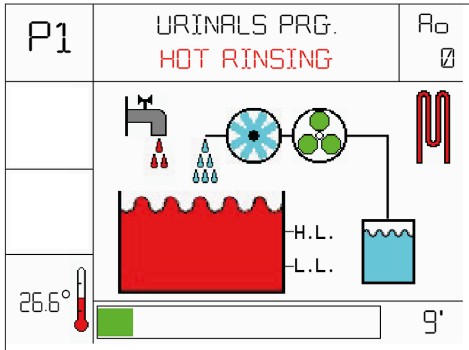

Fig. 12.5



**Phase 3**

6) The machine fills the tank with hot water and adds antiscald.



**Fig. 12.6**

7) The hot water is sprayed into the chamber through the EV5, EV6 and EV7 solenoid valves. The water is automatically discharged.

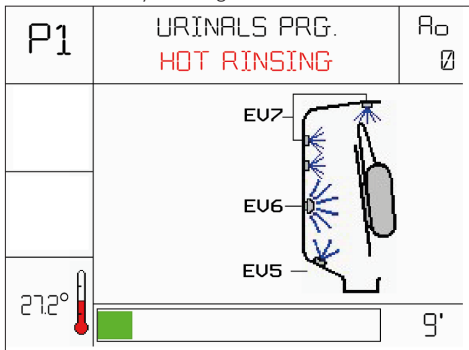

**Fig. 12.7**

**Phase 4**

8) Disinfection phase begins: the steam generator is heating the water up to 100°C/212°F and produces steam. Steam flows out of the steam generator and passes through the same pipes used for washing, until it reaches the chamber. A temperature of 85°C/185°F is reached and maintained for 1 minute inside the chamber.

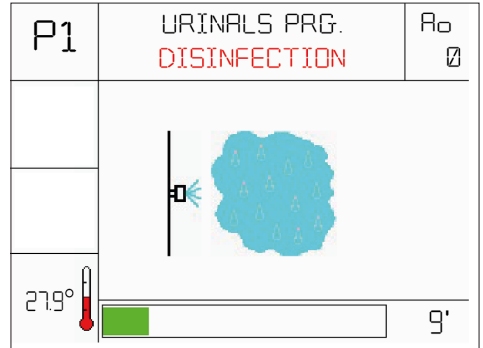

**Fig. 12.8**

**Phase 5**

9) The hot water with softener liquid, at around 45°C/113°F, enters in the steam generator and mixes with hot water remained after the disinfection at 100°C/212°F. The result is a water hotter than 65°C/149°F (disinfected water) that is used for the final rinse.

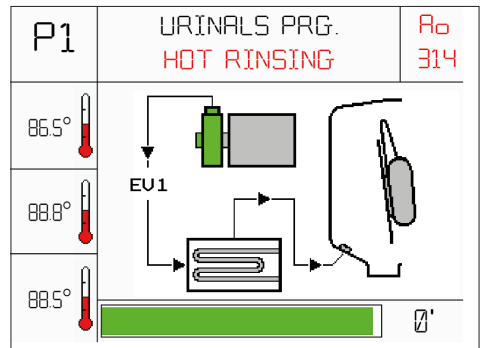

**Fig. 12.9**

## Phase 6

10) Cooling phase begins: the bedpan washer door remains locked until the chamber reaches a temperature below 75°C/167°F.

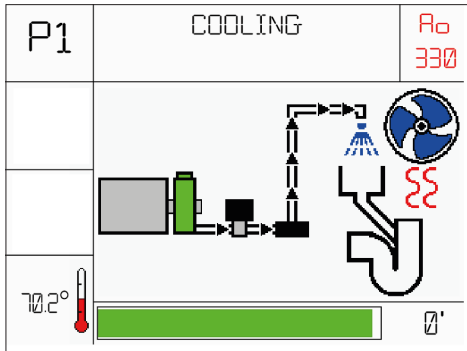

Fig. 12.10

11) End of the cycle. Open the door (if the machine is automatic, the door opens automatically) and remove the items.

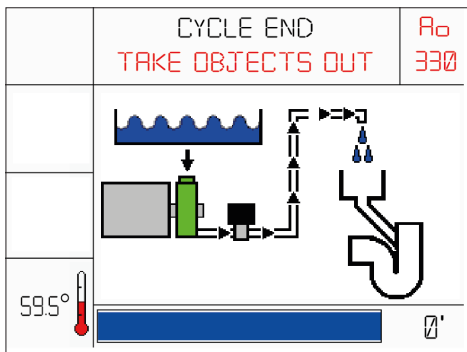

Fig. 12.11

## 8.1.3 ALARM MESSAGES

The machine is equipped with an alarm system that indicates malfunctions detectable with an audible signal (buzzer) and a screen on the graphic display of the control panel.

At first the image concerning the alarm is displayed (for 5 seconds); then the alarm description is displayed (for 10 seconds).

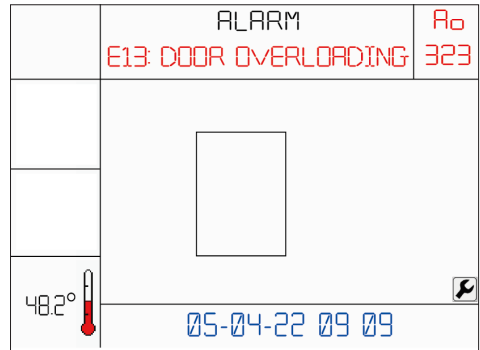

Fig. 13

If the program is interrupted because of an alarm, follow the message shown on the display to solve the problem. Then press RESET key and restart the program.



**IMPORTANT NOTE!** The door cannot be opened at the end of the wash cycle until the temperature inside the wash basin and inside the steam generator have dropped below their preset safety temperature. The display shows the message "Cooling". Wait until door opening is enabled.

For the alarms, description and possible solutions see Annex 10.5.

## 8.1.4 USER SETTINGS MENU



**WARNING!** Any change to the menu must be done according with a technician. Accessing the menu and changing functional parameters could affect the functionalities of the device. The execution of unauthorised changes, both on the machine and on the programs, are the cause of cancellation by the manufacturer of the warranty granted.

The settings menu is accessible only with the password dedicated to technician that can access and change any settings. The user can modify the settings only if guided by a technician or by the manufacturer in order to avoid damaging the machine.

To access the settings menu the procedure is as follows:

- 1) Machine in stand-by.
- 2) Open the panel where there is the display board (4 fig. 2.1).

 **WARNING!** Hold the door firmly once unlocked with the key, as there is a risk of it falling to the ground.

- 3) Press the black button on the back of the display board
- 4) Close the door with the key
- 5) Insert technician password "\*\*\*\*\*": press button 1-Urinals program (1 Fig. 10) four times.

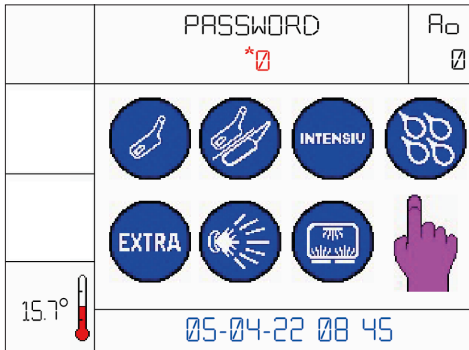

**Fig. 14**

The buttons and their operation are shown below, contextualised according the menu in which you are located:

- Use buttons 3 and 4 (Fig. 10) to navigate back and forth the menu.
- Press button 1 (Fig. 10) to access the entry of the menu selected.
- Within the parameter, use buttons 3 and 4 (Fig. 10) to change the value of the red parameter and press button 1 to confirm.
- Press buttons 1 and 2 (Fig. 10) to go back and forth to the other blue parameters.
- Press RESET to return to the previous menu.

**8.1.5 DATE AND TIME SETUP**

Enter the menu with the technician password, following the steps described in the paragraph "user settings menu".

Select SET CLOCK menu and change date and time.

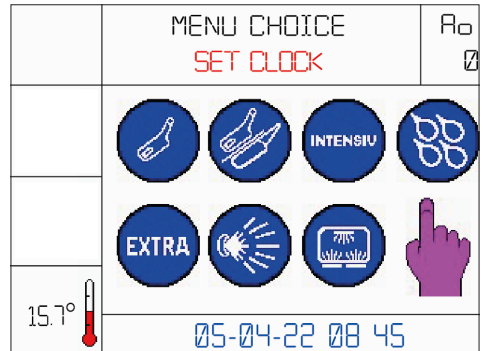

**Fig. 15**

Date and time are changed on the display and on the printer.

**8.1.6 LANGUAGE SETUP**

To change the display language, enter the menu with the technician password, following the steps described in the paragraph "user settings menu".

Select VARIOUS PARAMETERS menu and scroll until the "Language" setting. Select the desired language from those available.

**8.1.7 PROCEDURE FOR PASSWORD CHANGE (AUTHORISED TECHNICIANS ONLY)**

To generate a new technician password enter the menu with technician level, following the steps described in the paragraph "user settings menu".

Select SET PASSWORD menu and change technician password by pressing buttons 3 and 4 for choose numbers and button 1 to confirm.

See Annexes 10.3 and 10.4.

**8.1.8 SETTINGS**

See Annexes 10.1 and 10.2.

**8.2 ALARMS**

See Annex 10.5.

**8.3 WARNINGS**

See Annex 10.6.

**9 MAINTENANCE**

**9.1 GENERAL INFORMATION**

Maintenance is a set of periodic and predefined operations aimed at maintaining the machine functionality in all its aspects as a result of intrinsic wear and use.

It should be remembered that the lower operating cost and a long life of the machine depend on the continuous

observance of what is reported in this manual.



**WARNING!** *The bedpan washer maintenance operations must be carried out with the machine completely switched off (turn off the main circuit breaker).*



**WARNING!** *To prevent bacterial proliferation, the machine is equipped with a Self Disinfection System (S.D.S.) that automatically perform a disinfection program 24 hours after the last cycle.*

The routine maintenance operations and the frequency of maintenance are described in the Maintenance Logbook.

The Maintenance Logbook is an integral part of this manual. If the Maintenance Logbook is missing, contact your dealer or distributor.



**WARNING!** *it is the user's obligation to fill in and keep updated the Maintenance Logbook. The incorrect or incomplete compilation of the Maintenance Logbook will void the warranty.*

### 9.1.1 PERIODIC MAINTENANCE REQUEST

After a certain time or a certain number of operating hours, the display shows «MAINTENANCE», if enable. This signal has no influence on the machine operation, contact the customer service or the dedicated technical assistance for periodic maintenance.



**WARNING!** *Periodic maintenance is carried out by the technician under guarantee only if the user has correctly and regularly carried out all ordinary maintenance operations and if the user has filled out and kept up-to-date the Maintenance Logbook.*

### 9.1.2 PERSONAL PROTECTIVE EQUIPMENT (PPE)

The operator engaged in this type of intervention must wear PPE and must be sure that no other unauthorised person is present in the operating area of the machine. Before maintenance, start a program to wash the washing chamber.

### 9.1.3 CLEANING PRODUCTS

Clean the outside of the machine with products suitable for stainless steel, glass and plastic materials.



**HAZARD!** *Products unsuitable for cleaning stainless steel, glass and plastic materials may irreparably damage non-interchangeable parts of the appliance and render the machine unusable.*

If a suitable cleaning liquid is not available, a mixture of water (75%) and alcohol (25%) may be used. Cleaning should be carried out with a smooth (non-scratchy) cloth moistened with the appropriate liquid.



**WARNING!** *Do not spray the machine or near it with water jets, or with pressure devices.*



**HAZARD!** *DO NOT SOAK THE CLOTH to prevent excess liquid from entering electrically hazardous areas for the operator.*

The keypad and display should be cleaned with a mixture of water and alcohol or with mild detergents. The washing chamber is automatically cleaned. In case of need, for an extra cleaning of the washing chamber, run a rinse cycle without introducing instruments.



**WARNING!** *Do not use steel wool, steel brushes, bleach (bleach cause the oxidation of the stainless steel surface and consequent change of color) or any cleaning agent containing bleach or anything abrasive to cleaning the device. Doing so will damage the device!*

## 9.2 WEEKLY CHECKS

### 9.2.1 ANTI-SCALE

Periodically check the level of anti-scale product contained in the drum located in the compartment below the wash basin. A label near the cap indicates the type of liquid contained in the drum. A message on the display warns when the liquid is getting low and when it is totally finished.

Moreover, the machine has a volumetric meter, which controls the quantity of passing liquid. This is another control system: the meter stops the working cycle and the display will show an alarm every time that the dispenser pump doesn't work well or the liquid is totally finished.

### 9.2.2 DETERGENT

Periodically check the level of detergent liquid contained in the drum (when present) located in the compartment below the wash basin. A label near the

cap indicates the type of liquid contained in the drum. A message on the display warns when the liquid is getting low and when it is totally finished.

Moreover, the machine has a volumetric meter, which controls the quantity of passing liquid. This is another control system: the meter stops the working cycle and the display will show an alarm every time that the dispenser pump doesn't work well or the liquid is totally finished.

### 9.3 WHAT TO DO IF THE MACHINE HASN'T BEEN USED FOR A LONG TIME

#### 9.3.1 STORAGE TANK

If the machine hasn't been used for a long time without electrical supply, it is good to empty manually the storage tank using the drainage valve under it: in this way the proliferating of bacteria is avoided.

In every 15883 machine this operation is automatic every time the machine doesn't work for a long time, even without electrical supply.

#### 9.3.2 STEAM GENERATOR

If the machine hasn't been used for a long time without electrical supply, it is good to empty manually the steam generator using the drainage cap under it: in this way the proliferating of bacteria is avoided.

### 9.4 ROUTINE MAINTENANCE

Routine maintenance operations are performed by the user and includes all those jobs needed to keep the machine clean and functioning. It is mandatory to perform these operations regularly or when necessary and the user is responsible for verifying their regularity. For routine maintenance operations refer to the Maintenance Logbook provided in the machine's pack.



**WARNING!** it is the user's obligation to fill in the Maintenance Logbook correctly and regularly. The incorrect or incomplete compilation of the Maintenance Logbook will void the warranty.

#### 9.4.1 CLEANING THE HUMAN WASTE CONTAINERS HOOK/SUPPORT AND MACHINE'S SURFACES

Sometimes it may be necessary to remove the human waste containers hook/support to replace it or to perform routine, extraordinary maintenance or cleaning. To remove the support just pull it towards yourself until the support connections are released from their two anchor plates. To reinsert the support perform this operation in reverse order.

For machine's surfaces cleaning follow the instructions in 9.1.3.



**WARNING!** Whenever a new support is inserted make sure it is correctly fastened to its connections.

### 9.5 SPECIAL MAINTENANCE

Special maintenance operations are not foreseen by the user but must be performed exclusively by the technical assistance or by an authorised and qualified service personnel that must refer to the Service Manual.

How to carry out special maintenance operations and the frequency of maintenance are described in the Service Manual.

**Contact the manufacturer service for special maintenance.**



**WARNING!** Special maintenance is carried out by the technician under guarantee only if the utilizer has correctly and regularly carried out all ordinary maintenance operations and if the utilizer has filled out and kept up-to-date the Maintenance Logbook.

#### 9.5.1 CLEANING THE WATER INLET FILTERS

Proceed as follows to clean the water inlet filters.

- 1) Look at the back of the machine at the bottom (Fig. 16).
- 2) Unscrew the cap.
- 3) Remove the filter.
- 4) Clean the filter.
- 5) At the end of the cleaning operations, refit the filters in succession.

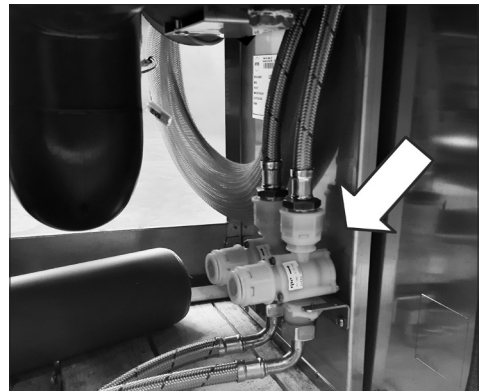

Fig. 16



**WARNING!** It is mandatory to record the annually water inlet filters cleaning in the Maintenance Logbook.

### 9.5.2 CLEANING OF SMALL ROTATING NOZZLE

- 1) Unscrew the fixing screw of the head of nozzle.
- 2) Dismount the rotating head.
- 3) Remove the nozzle's pin.
- 4) Clean them with water of compressed air.
- 5) Reinstall all.



**WARNING!** It is mandatory to record the annually rotating nozzle cleaning in the Maintenance Logbook.

### 9.5.3 REPLACING OF DOOR GASKET

- 1) Remove the old gasket.
- 2) Insert the upper angles of gasket.
- 3) Press inside all the upper part of gasket.
- 4) Insert the lower ends inside the slots.
- 5) Help the sliding of the gasket with some oil.
- 6) Slides the gasket up the end of the slot.
- 7) Press inside the sides of the gaskets.



**WARNING!** It is mandatory to replace the door gasket as indicated in the Maintenance Logbook. In case of intensive use of the machine it is recommended to increase the frequency of maintenance.

### 9.5.4 CLEANING OF LEVEL PROBE IN STORAGE TANK

- 1) Power off the machine.
- 2) Remove the upper panel of the device, using the provided key.
- 3) Disconnect the connector from the probes
- 4) Extract the probes from the water tank.
- 5) Clean the steel rods, possibly using softener liquid and being careful not to scratch them.
- 6) Reinsert the probes in their housing;
- 7) Restore the power to the device.



**WARNING!** It is mandatory to record the annually level probe cleaning in the Maintenance Logbook.

### 9.5.5 REPLACING THE AIR SUCTION FILTER

The machine is equipped with an «absolute» «HEPA H14» air filter, in compliance with EN 1822.

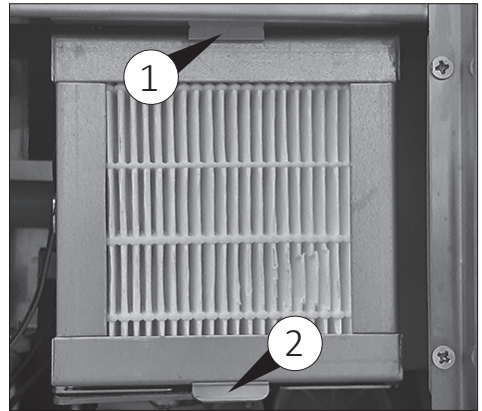

**Fig. 17**

If the filter is dirty, replace it by following the instructions below:

- 1) Remove the cover panel (4 Fig. 2.1 and Fig. 2.2).
- 2) Remove the filter by lifting one of the two hooks (1 or 2 Fig. 17).
- 3) Place the new filter, taking care to position the black gasket on the machine side (fig. 18).



**Fig. 18**

- 4) Replace the cover panel.



**WARNING!** It is mandatory to replace the HEPA H14 filter as indicated in the Maintenance Logbook. In case of intensive use of the machine it is recommended to increase the frequency of maintenance.

## 9.6 TROUBLESHOOTING

The Annex 10.7 lists the main malfunctions, with relative causes and recommended solutions, that the machine may present during its operation.

The interventions that may become necessary must be carried out by experienced and qualified operators.

If the problems persist or appear even more often after performing the work reported below, contact the technical assistance or an authorised and qualified service personnel.

## 9.7 EQUIPMENT DISPOSAL

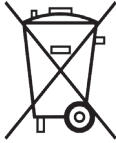

Respect the laws in force in the country of use of the machine, in relation to the use and disposal of the products used for the cleaning and maintenance of the machine, as well as observe what the manufacturer of these products recommends.

When disposing of a bedpan washer, it is necessary to remember that it can still be contaminated by blood and other organic liquids, pathogenic germs, genetically modified material, toxic or carcinogenic substances, heavy metals, etc. and, therefore, it must be decontaminated before its disposal.

For safety and environmental protection reasons, dispose of all chemical residues in compliance with applicable legislation. When performing this operation, use protective goggles and gloves. Remove or disengage the door lock so that no one can get closed inside the machine, e.g. children playing. Finally, deliver the machine to a suitable and authorised collection centre.

The electrical and electronic devices to be disposed of contain reusable materials.

They also contain components harmful for the environment, but necessary for the correct operation and safety of the equipment. If they are not disposed of correctly or are disposed of as household waste, these components can damage human health and the environment. Never dispose of the old bedpan washer among conventional waste.

Unauthorised product disposal by the user entails the application of very strict administrative sanctions provided for by current legislation. Enquire about this at your local dealer. Depending on the country in which one resides and the regulations in force, one is obliged to delete the data referring to people and stored on the

machine.

**Finally, make sure that the old equipment is kept out of reach of children until its actual disposal.**

## 9.8 SPARE PARTS

The various components of the machine can be requested directly to the manufacturer by providing the following data:

- **Model, serial number and year of construction of the machine.** These data are stamped on the identification plate fitted on each individual machine.
- **Description of the part and required quantity.**
- **Shipping method.** If this item is not specified, the manufacturer, although dedicating particular care to this service, is not liable for any shipping delays due to force majeure. Shipping costs are always charged to the recipient. Goods travel at the risk and danger of the customer, even if sold carriage free.

**Finally, please note that the manufacturer is always available for any assistance and/or spare parts.**

## 10 ANNEX

### 10.1 MENU PARAMETER TABLE

All parameters that can be changed with the technician are listed below.



*WARNING! Do not change any of the parameters with the "Only with technician" checkbox without the support of a service personnel or the manufacturer. Unauthorized modification may cause damage to the machine. The manufacturer is not responsible for failure to follow these instructions. The execution of unauthorised changes, both on the machine and on the programs, are the cause of cancellation by the manufacturer of the warranty granted.*

ID	Parameter Name	Min	Max	Description	Factory Default	Only with technician*
<b>PROGRAM</b>						
1	Time phase*	0	99	Set the duration time for each phase of the selected program and the duration time of the disinfection once the set temperature is reached	NA	YES
2	Softener erogation*	0.4 1	18 45	Set the dosage of antiscala dispensed	4.8 sec 12 ml	YES
3	Disinfection temperature*	80	90	Define the temperature required for items to be considered disinfected	85 °C	YES
<b>SET CLOCK</b>						
1	Date and time	DD/MM/YY HH:MM:SS		Set the current date and time		NO
<b>VARIOUS PARAMETERS</b>						
1	Delta temp. alarm*	0	20	Maximum phase temperature deviation	15°C	YES
2	N° cycles for service*	0	9900	Set number of cycles for maintenance request	0	YES
3	Heating timeout*	1	35	Maximum time for set temperature reached	10 min	YES
4	Disinfection timeout*	1	30	Maximum time for set disinfection temperature reached	15 min	YES



ID	Parameter Name	Min	Max	Description	Factory Default	Only with technician*
5	Water filling timeout*	3	10	Maximum time for fill the tank	5 min	YES
6	Detergent time L1*	0.4 1	18 45	Dosing with tank at minimum level	7.2 sec 18.0 ml	YES
7	Detergent time L2*	0.4 1	18 45	Dosing with tank at maximum level.	14.4 sec 36 ml	YES
8	Language	1	8	Selects the desired language for the display.	1	NO
9	Buzzer	OFF	ON	Enables or disables the acoustic signal.	ON	NO
10	Open temperature	25	100	This set the temperature value at which the door can be opened.	88°C	YES
11	Ev. steam temperature	0	100	This set the temperature value at which the "Steam Solenoid Valve" output trips.	75°C	YES
12	Minimum hysteresis	1	5	Minimum temperature value that must be maintained during disinfection.	2°C	YES
13	Maximum hysteresis	2	6	Maximum temperature value that must not be exceeded during disinfection.	3°C	YES
14	Time solvent	0.1 0.5	20.0 100.0	This set the time/dosing that the solvent pump operates.	5.0 sec 25.0 ml	YES
15	Action solvent	0	200	This set the time the solvent is left to work.	30 sec	YES
16	Solvent repetition	1	9	This indicate the number of repetitions of the solvent cycle.	1	YES
17	Time open door	0	25.0	This set the time the door takes to open up at the end of the cycle.	2.0 sec	YES
18	Time A_system	0	12000	Time value for which the ventilation system works.	60 sec	YES
19	A_system delay	0	65000	Time delay for A_System.	0 sec	YES
20	Autodisinfection	0	7	Choose which program starts automatically every 24 hours for disinfection.	3	NO

ID	Parameter Name	Min	Max	Description	Factory Default	Only with technician*
21	Autodisinfection time	0:0	23:59	Selects at what time the chosen program for automatic disinfection starts.	12:00	NO
22	Time C_system	0	12000	This sets the time value during which the cooling system works.	50	YES
23	Font table	EUR-JAP	EUR-CYR	Sets the font map to European/Japanese or European/Cyrillic.	EUR-JAP	NO
DEFAULT DATA						
1	Default data	OFF	ON	Restores factory data.	OFF	YES

\* The minimum and maximum values of these parameters may be different from those shown here because they depend on the values set in the manufacturer's menu.

## 10.2 MENU STRUCTURE

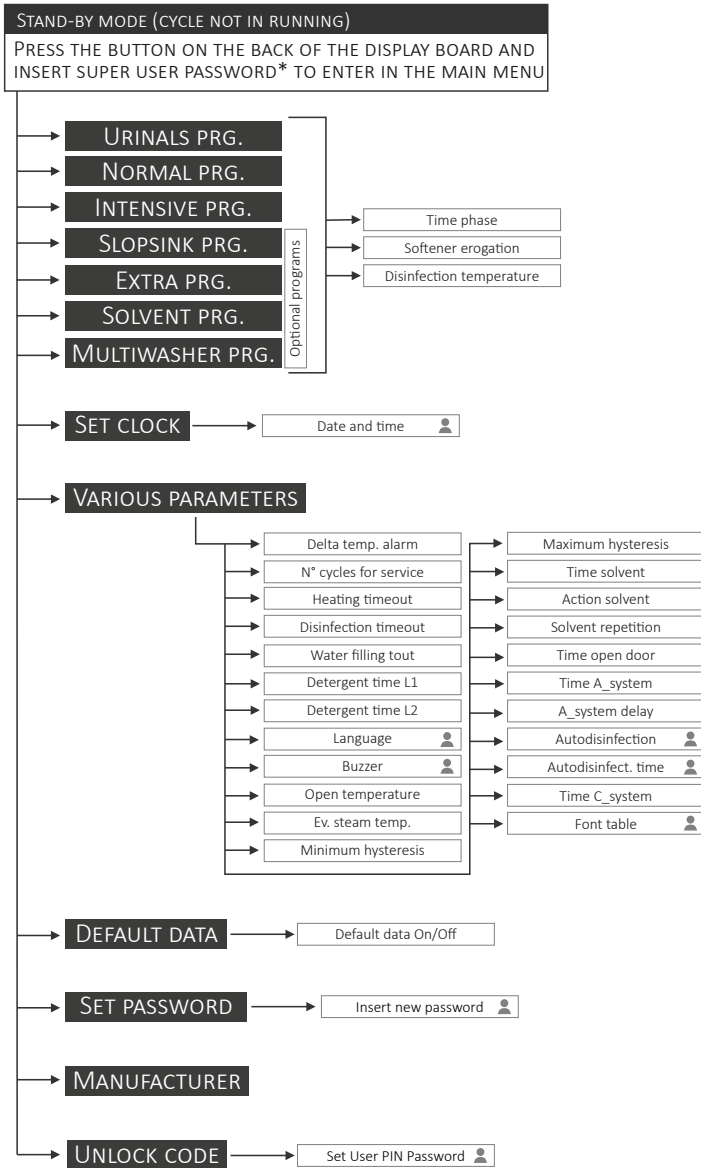

👤 Parameters that the user can change on his own, without the assistance of a technician or the manufacturer.

\* At the first access enter "\*\*\*\*" by pressing button 1 four times.

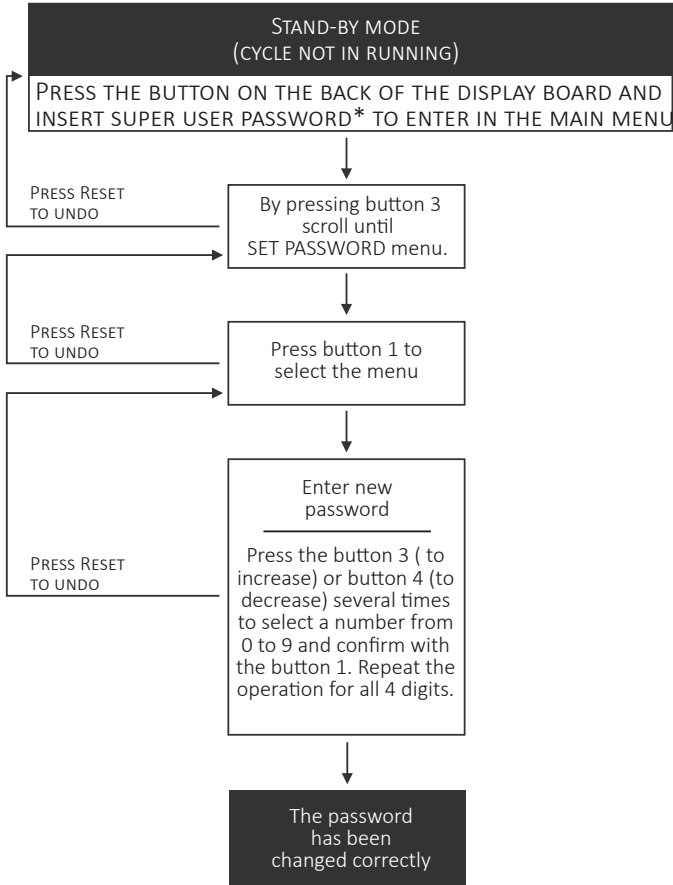
**10.3 PROCEDURE FOR SUPER USER PASSWORD CHANGE (AUTHORISED TECHNICIANS ONLY)**

\* At the first access enter "\*\*\*\*" by pressing button 1 four times.

### 10.4 PROCEDURE FOR USER PASSWORD CHANGE (AUTHORISED TECHNICIANS ONLY)

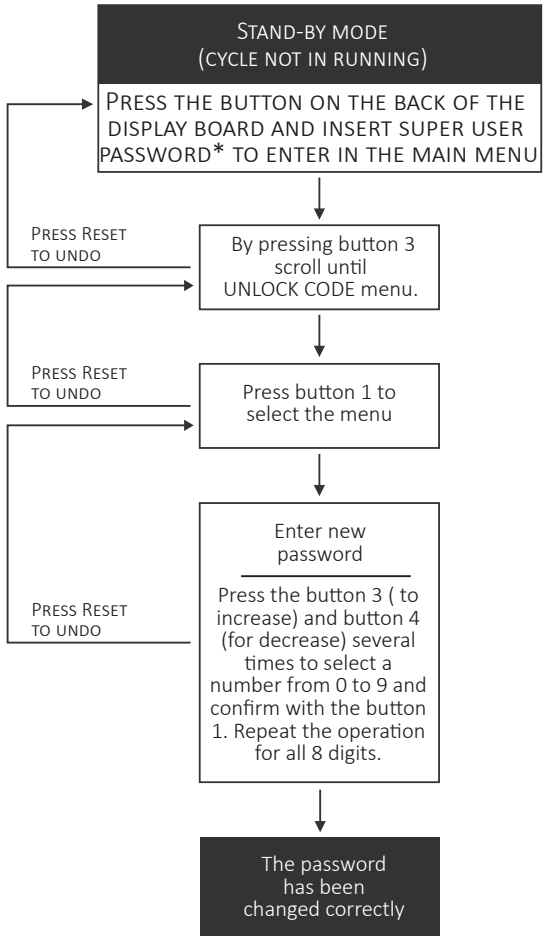

\* At the first access enter "\*\*\*\*\*" by pressing button 1 four times.

## 10.5 ALARM TABLE

ALARM	DESCRIPTION
E00 PTC PROBE BREAK	First firmware installation.
E01 PTC PROBE SHORT C	Chamber PT1000 / PT100 probes broken or short-circuited.
E02 NO PTC CONNECTED	No PT1000 / PT100 probes has been enabled (board setting error).
E03 PTC DETECTION	Mix of used probes (PT1000 / PT100).
E04 DETERGENT EMPTY	Detergent liquid tank empty- nozzle probe failure.
E05 SOLVENT EMPTY	Solvent liquid tank empty- nozzle probe failure.
E10 WATER NOT FILLED	Mains tap is closed or the filter is dirty.
E11 LOW W. LEV. OFF	Level probe malfunctioning in the water tank, faulty or disconnected.
E12 DOOR TIMEOUT	Door not open or close (only for automatic door).
E13 DOOR OVERLOADING	Door not open or close due to an obstacle (only for automatic door).
E14 DOOR SWITCHES.	Door not lock when closing is required or not unlock when opening is required (only for manual door).
E15 MANUAL INTERRUPT.	Emergency button pressure where present (only for automatic door).
E16 NO WASHING	Water has not dropped below the tank level probes at the end of the washing phases.
E17 SOFTENER SUPPLY	The liquid tank is empty, the filter is dirty, or there is a flow meter failure, in relation to the liquid softener.
E18 DETERGENT SUPPLY	The liquid tank is empty, the filter is dirty, or there is a flow meter failure, in relation to the liquid detergent.
E19 SOLVENT SUPPLY	The liquid tank is empty, the filter is dirty, or there is a flow meter failure, in relation to the liquid solvent.
E20 NO DISINFECTION	Heating element failure, steam leaks.
E21 STEAMGEN TIMEOUT	Mains tap is closed or the filter is dirty.
E22 SOL. VALVES OFF	No solenoid valve enabled for washing (board setting error).
E30 SOFTENER EMPTY	Softener liquid tank empty- nozzle probe failure.
E31 TEMP NOT REACHED	Heating element failure, steam leaks.
E32 ST.G. HEAT: TOUT	Heating element failure in the steam generator after a fixed time-out of 20 minutes.
E34 HOT WATER TEMP	Washing hot water temperature is lower than the set one.
E40 STGEN OVERHEATED	Overheating of the steam generator.
E41 LEAK PERIST.PUMP	Liquid leak.
E42 CLOGGED SIPHON	Drain pipe clogged.
E43 DOOR OPEN	Door opening during a program, due to malfunction of micro-switches.
E44 CALL SERVICE	Maintenance required.
E82 NTC2 PROBE BREAK	Steam generator NTC probe broken or disconnected.
E83 NTC2 PROBE SHORT C	Steam generator NTC probe short-circuited.
E84 CYCLE "n" INTERRUPTED	Interrupted cycle due to alarm or black-out.
E85 CYCLE ABORTED	After pressing the reset button while alarm E84 is displayed.
E86 MAX TEMPERATURE	Chamber heating elements failure or chamber PT1000 / PT100 probe malfunction.

**10.6 WARNINGS TABLE**

WARNING TYPE	DESCRIPTION	ACTION
Refill Softener	The anti-scale product level in the drum is getting low.	Prepare a replacement drum to use when the liquid is finished (a dedicated message will appear on the display)
Refill Detergent	The detergent (when provided) level in the drum is getting low.	Prepare a replacement drum to use when the liquid is finished (a dedicated message will appear on the display).
Refill Solvent	The solvent (when provided) level in the drum is getting low.	Prepare a replacement drum to use when the liquid is finished (a dedicated message will appear on the display).
Close the door	This message is displayed when a wash program has been selected but the door, being open, prevents the machine from starting.	Close the door.
Call Service	A technician must be called to solve a frequent problem or machine malfunction.	Contact the customer service.
Maintenance	It is time to perform scheduled periodic maintenance.	Contact the customer service or the dedicated technical assistance for periodic validation.

**10.7 TROUBLESHOOTING**

PROBLEM	CAUSE	SOLUTION
1 The machine does not start	The fuse of the micro board has tripped.	Enable the fuse / switch of the electrical system.
2 The program does not start	Door not closed correctly.	Check door closure.
3 The program stops	No chemical products.	Turn off the machine and fill the containers.
	Water flow closed.	Open the water flow.
4 The operating temperature for the program is not reached	The thermostat sensor in the washing chamber is covered with deposits.	Clean the thermostat sensor.

**10.8 FUSES**

FUSES OF THE MACHINES	
F1	
For all power supply	5x20 T8A









# Index

TECHNICAL SPECIFICATIONS . . . . .	2	8.1.1 DISPLAY SCREENS . . . . .	23
1 SYMBOLS USED IN THE MANUAL . . . . .	4	8.1.2 PROGRAM 1 URINALS . . . . .	24
2 PRESENTATION . . . . .	4	8.1.3 ALARM MESSAGES . . . . .	26
2.1 FIELD OF APPLICATION . . . . .	5	8.1.4 USER SETTINGS MENU . . . . .	26
2.1.1 INTENDED USE . . . . .	5	8.1.5 DATE AND TIME SETUP . . . . .	27
2.1.2 INTENDED USERS . . . . .	5	8.1.6 LANGUAGE SETUP . . . . .	27
2.1.3 INTENDED USE OF ENVIRONMENT . . . . .	5	8.1.7 PROCEDURE FOR PASSWORD CHANGE (AUTHORISED TECHNICIANS ONLY) . . . . .	27
2.2 LABEL SPECIFICATION . . . . .	5	8.1.8 SETTINGS . . . . .	27
2.3 WARRANTY . . . . .	6	8.2 ALARMS . . . . .	27
2.4 WARRANTY EXCLUSIONS . . . . .	6	8.3 WARNINGS . . . . .	27
2.5 PRODUCT ANALYSIS . . . . .	7	9 MAINTENANCE . . . . .	27
2.5.1 INLET WATER QUALITY . . . . .	7	9.1 GENERAL INFORMATION . . . . .	27
2.6 TECHNICAL DATA . . . . .	8	9.1.1 PERIODIC MAINTENANCE REQUEST . . . . .	28
2.7 PICTOGRAMS SPECIFICATION . . . . .	8	9.1.2 PERSONAL PROTECTIVE EQUIPMENT (PPE) . . . . .	28
2.8 MAIN COMPONENTS OF THE MACHINE . . . . .	8	9.1.3 CLEANING PRODUCTS . . . . .	28
2.9 SUPPORTS . . . . .	8	9.2 WEEKLY CHECKS . . . . .	28
3 SAFETY AND PREVENTION . . . . .	9	9.2.1 ANTI-SCALE . . . . .	28
3.1 GENERAL WARNINGS . . . . .	10	9.2.2 DETERGENT . . . . .	28
3.1.1 USER OBLIGATIONS . . . . .	10	9.3 WHAT TO DO IF THE MACHINE HASN'T BEEN USED FOR A LONG TIME . . . . .	29
3.1.2 INSTALLER OBLIGATIONS . . . . .	10	9.3.1 STORAGE TANK . . . . .	29
3.1.3 OPERATOR OBLIGATIONS . . . . .	10	9.3.2 STEAM GENERATOR . . . . .	29
3.1.4 MAINTENANCE SERVICE PERSONNEL OBLIGATIONS . . . . .	11	9.4 ROUTINE MAINTENANCE . . . . .	29
4 HANDLING . . . . .	11	9.4.1 CLEANING THE HUMAN WASTE CONTAINERS HOOK/ SUPPORT AND MACHINE'S SURFACES . . . . .	29
4.1 STORAGE . . . . .	13	9.5 SPECIAL MAINTENANCE . . . . .	29
5 INSTALLATION . . . . .	13	9.5.1 CLEANING THE WATER INLET FILTERS . . . . .	29
5.1 ELECTRICAL CONNECTION . . . . .	13	9.5.2 CLEANING OF SMALL ROTATING NOZZLE . . . . .	30
5.1.1 ELECTRICAL CONNECTION . . . . .	14	9.5.3 REPLACING OF DOOR GASKET . . . . .	30
5.2 WATER CONNECTION . . . . .	15	9.5.4 CLEANING OF LEVEL PROBE IN STORAGE TANK . . . . .	30
5.3 CONNECTION OF THE DRAIN TRAP . . . . .	16	9.5.5 REPLACING THE AIR SUCTION FILTER . . . . .	30
5.3.1 DRAIN CONNECTION . . . . .	16	9.6 TROUBLESHOOTING . . . . .	31
5.4 CHEMICALS . . . . .	16	9.7 EQUIPMENT DISPOSAL . . . . .	31
5.4.1 REFILL PROCEDURE . . . . .	17	9.8 SPARE PARTS . . . . .	31
5.4.2 USING AND STORING CHEMICALS . . . . .	17	10ANNEX . . . . .	32
6 DESCRIPTION OF THE APPLIANCE . . . . .	17	10.1MENU PARAMETER TABLE . . . . .	32
6.1 CONFIGURATIONS . . . . .	18	10.2MENU STRUCTURE . . . . .	35
6.1.1 DISINFECTING SYSTEMS . . . . .	18	10.3 PROCEDURE FOR SUPER USER PASSWORD CHANGE (AUTHORISED TECHNICIANS ONLY) . . . . .	36
6.1.2 SAFETY THERMOSTAT . . . . .	18	10.4 PROCEDURE FOR USER PASSWORD CHANGE (AUTHORI- SED TECHNICIANS ONLY) . . . . .	37
6.1.3 AUTOMATIC DOOR . . . . .	18	10.5 ALARM TABLE . . . . .	38
6.1.4 N.T.T. (NO TOUCH TECHNOLOGY) . . . . .	19	10.6WARNINGS TABLE . . . . .	39
7 USING THE MACHINE . . . . .	19	10.7TROUBLESHOOTING . . . . .	39
7.1 COMMISSIONING INSTRUCTIONS . . . . .	19	10.8FUSES . . . . .	39
7.2 BEFORE USE . . . . .	19		
7.2.1 PREPARING THE LOAD . . . . .	20		
7.3 PROGRAMS . . . . .	20		
7.3.1 PROGRAM STRUCTURE . . . . .	20		
7.4 STARTING THE MACHINE . . . . .	20		
7.4.1 BEFORE STARTING THE PROGRAM . . . . .	21		
7.4.2 STARTING THE PROGRAM . . . . .	21		
7.4.3 PROGRAM END . . . . .	22		
7.4.4 EXTRACTING THE LOAD . . . . .	22		
8 CONTROL PANEL . . . . .	22		
8.1 DISPLAY . . . . .	23		



**Australia**

Tel: +61 1300 347 944

**New Zealand**

Tel: +64 9 414 5575

**Singapore**

Tel: +65 9107 8943

## DETERGENTS & AFTER SALES SUPPORT

To request detergents or after sales support contact your local Rhima Service centre:

Australia: **(+61) 1300 347 944**

New Zealand: **(+64) 9 414 5575**

Singapore: **(+65) 9107 8943**



### **Mediwash**

5L Bottle

For washing bedpans,  
bottles & instruments

