

# Operator's Manual

## **HIGH SPARKLE 45** Washer



# INSTRUCTION MANUAL FOR DISHWASHERS



It is important to keep this instruction manual near the appliance for future consultation.

If the appliance is sold or transferred to another user, make sure this manual remains with the appliance so that the new owner is informed about the warnings and operation of the appliance. These instructions are given for safety reasons and they must be read carefully before installing or using the appliance.

## GENERAL INSTRUCTIONS

- The appliance must be connected to water and electrical supplies by qualified tradespersons only and according to local regulations.
- The appliance must be used by adults only. Do not let children play with, or operate this machine.
- Only persons trained to use this dishwasher are permitted to operate it.
- This appliance has been designed to wash food preparation and eating utensils. It has NOT been designed to wash objects soiled with petrol, paint, remnants of steel or iron, corrosive chemical products such as acids, alkalis, or solvents or any item that cannot be immersed in water.
- Do not open the appliance door or lift hood while the appliance is operating. The appliance has a safety device which stops operation if the door or hood is accidentally opened.
- After using the appliance, isolate the electric and water supply.
- Do not attempt to repair the appliance. Repairs made by unqualified persons may cause further damage and will void warranty.
- Repairs and servicing of this appliance must be carried out by Rhima personnel only.

## IMPORTANT CUSTOMER INFORMATION

- To request a service, detergents or rinse additive contact your local Rhima Service centre below:

Australia: **1300 347 944**

New Zealand: **0800 902 054**

Singapore: **+65 9107 8943**

## ELECTRICAL INSTALLATION

This appliance is intended to be connected to a **15amp** electrical supply and **must be earthed**.

## PLUMBING INSTALLATION

This appliance should be connected to a hot water supply (Max 65°C ) for in accordance with **Australian Standard AS/NZS 3500.1**. for optimum performance.

The water supply pressure should be a minimum 200 kPa at all times and flow rate should be at least 10 litres per minute. A static pressure higher than 600 kPa (73.5 psi) requires a pressure reducing valve upstream of the supply line. If water pressure is below 150 kPa, the use of a rinse booster pump is recommended.

This appliance is designed to drain to a tundish. Waste connection to a spigot is not recommended and may cause draining issues.

The drainpipe should withstand 70°C (158°F) in continuous duty conditions.

The grey water drain hose must have a fixed watertight seal above the tundish in accordance with the Australian Standard AS/NZS 3500.2.

**A DIAGRAM SHOWING THE CORRECT METHOD OF WASTE INSTALLATION IN ACCORDANCE WITH THE AUSTRALIAN STANDARD AS/NZS 3500.2 IS BELOW**



INSTALLATION TO BE IN ACCORDANCE WITH AUSTRALIAN STANDARD AS/NZS 3500.2

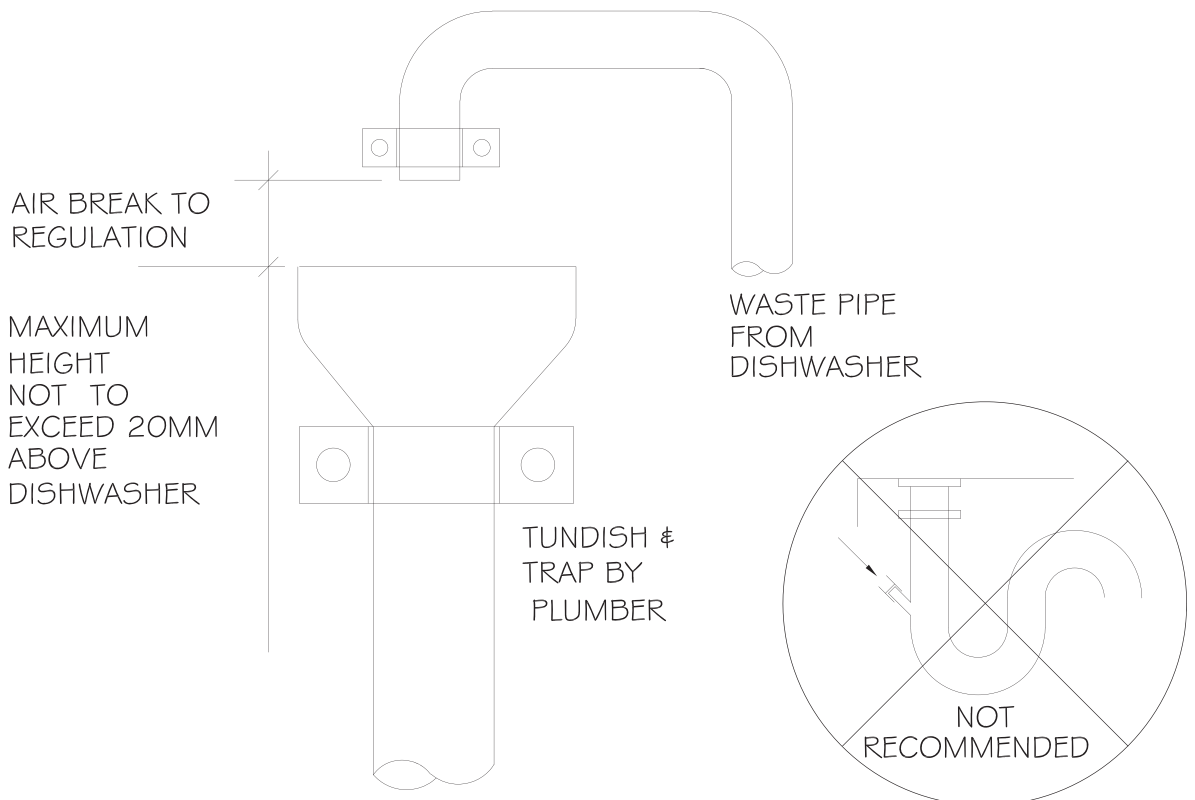

PUMPED WASTE

## CONTROL PANEL AND RELATIVE SYMBOLS

### Keys

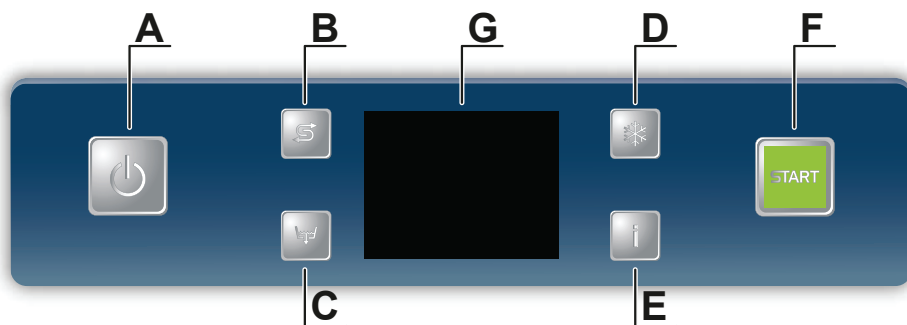

- A) Switching – On / STAND BY key
- B) Regeneration key (optional)
- C) Drain key
- D) Extra cold rinse key (optional)
- E) Info key
- F) START key to start up cycle / select cycle
- G) Display

### 2.2 Display

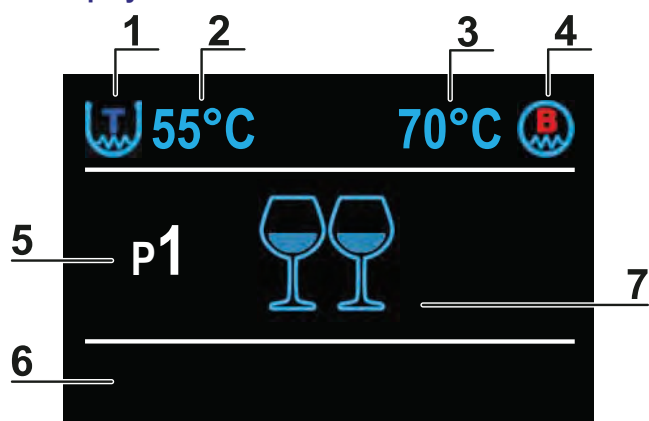

The display's indications, when machine ready, are listed below:

- 1) **Tank status icon.** If the letter **T** is red the heating element is ON.
- 2) Tank temperature
- 3) Boiler temperature
- 4) **Boiler status icon.** If the letter **B** is red the heating element is ON.
- 5) Cycle Code
- 6) Cycle Name
- 7) Cycle Icon

## OPERATION

### Machine start-up

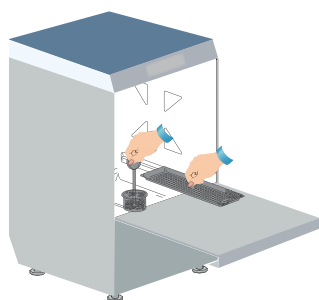

pict. 1

- Check if the pump suction filter is properly inserted in its seat in the wash-tank bottom (see pict. 1). This filter must be cleaned every 20 wash-cycles or whenever necessary.

#### **DO NOT use the appliance without the filters.**

- Put the surface filters in place (see pict. 1).
- Shut the machine door.
- Turn the water valve "open".
- Turn the main power switch ON.

• The machine is on **STAND-BY**. In the **G** display are shown: the symbol , the date and time and a possible notice of operations to be carried out by the user.

The key **A** turns red. The key **C** turns blue. If the machine is provided with the Water Softener optional also the key B turns blue.

- Press and hold the key **A**. The key **A** turns green.

- For the first 4 seconds the key **Start F** turns green and on the display **G** appears the last cycle carried out before switching the machine off. During this time it is possible to pre-select the cycle to start washing.

Keep pressed the key **Start F** to scroll the available cycles' list, until the desired one appears. Release the key. This function allows to save time in start-up phase if a cycle with lower operating temperatures is selected (i.e.: Rinse 70°C instead of 82°C). The key **Start F** turns red.

- If the tank was not drained after the previous use or if the tank water temperature is below 50°C, the machine proceeds with a tank draining. In any case remember that if the machine is not used the tank must be drained (see **WARNINGS**).

Even if the tank is empty the draining pump runs for a few seconds to eliminate any water residual.

- The machine proceeds to tank filling and heating, by steps. The display **G** alternatively shows the messages **FILLING WATER** and **HEATING**.

By pressing the key **Info E** it is possible to display the tank and boiler temperatures.

The machine is ready to wash when both tank and boiler are filled and the set temperatures are reached.

### Start the wash cycle





- Insert the rack filled with objects to wash. The objects must be correctly placed in the rack.

- If the desired cycle hasn't been selected before, it is possible to do it in this moment by keeping press the key **Start F**.

The display will show in sequence all these available programs.

Once the wanted program is displayed, release the button.

### Available programs:

Cycle Code	Cycle name	Icon	Total time*		Note
			Rack 40	Rack 50	
P0	CUSTOM		**	**	Partial drain cycle with adjustable time and temperatures
P1	GLASSES - SHORT		60"	60"	Partial drain cycle with rinse temperature at 70°C
P2	GLASSES - MEDIUM		120"	120"	Partial drain cycle with rinse temperature at 70°C
P3	GLASSES - INTENSIVE		180"	180"	Partial drain cycle with rinse temperature at 70°C
P4	BEER GLASSES		90"	90"	Partial drain cycle with rinse temperature at 82°C
P5	BEER MUGS		120"	180"	Partial drain cycle with rinse temperature at 82°C
P6	CLEAN STANDARD		120"	180"	Total drain cycle with rinse temperature at 82°C
P7	CLEAN LONG		170"	360"	Total drain cycle with rinse temperature at 82°C

\*The indicated time is valid only if the machine has reached the boiler temperature set.

\*\*The cycle **P0** is a customizable cycle according to the user's needs, to be set by a technician during the machine installation.

- Close the door. Start the cycle by pressing the key **Start F**.  
The display shows a percentage indicating the cycle progress. On the lower part of the display is shown the phase of the cycle (wash, drain or rinse). The key **Start F** turns blue.
- If the door is open, the key **Start F** lights in red and the cycle can not be started. By pressing the key **Start F** the display indicates **DOOR OPEN**.
- Keep pressed the key **Start F** for about 2 seconds to stop the cycle.  
The percentage is reset if the cycle is stopped.
- At the end of the cycle the key **Start F** alternatively flashes in blue/green. The display shows the 100% value and, the message **CYCLE ENDED** on the lower part.

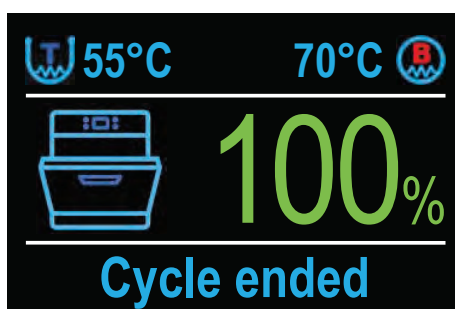
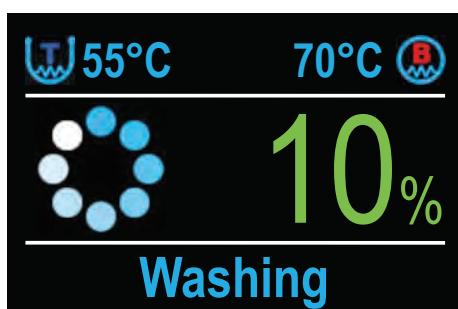

If enabled, a buzzer signals the end.

**Note:** At cycle-end, keeping the door closed, objects will not dry. The machine is equipped with a device that allows the partial opening of the door, to let the steam flow gradually. Keep the door in this position for a few seconds and then open it wide to remove the rack (see pict. 2).

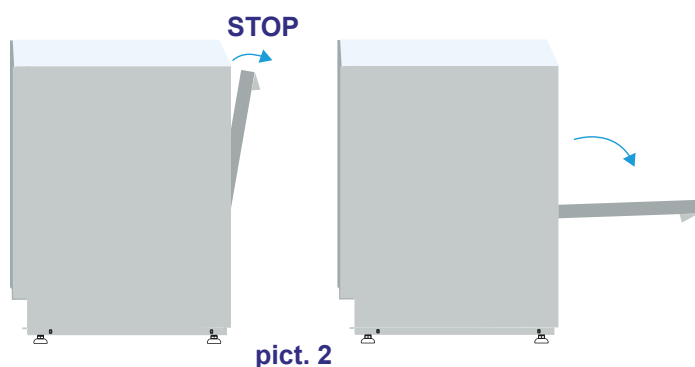

**Note:** We recommend to change the tank water, by means of another filling, at least twice a day, or whenever needed. The machine is set to change all the wash-water automatically, every 30 cycles.

### Switching OFF

- Keep pressed the key **A** until it lights in red.
- Drain completely the wash tank by pressing the key **C** which activates the drain pump.
- At the end of the day, clean the machine (see Page 10. **Maintenance**).
- Shut the water valve.
- Switch the main power switch OFF.

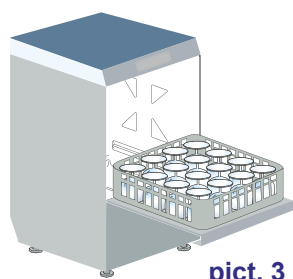

### Cutlery and crockery loading

Before cutlery and crockery loading in the machine, coarsely clean them from the leftover food. It isn't necessary to rinse the cutlery and crockery under water.

**ATTENTION: Do not wash articles polluted with petrol, paint, chips of steel or iron, ash, sand, wax, lubricant grease. These substances damage the machine. Do not wash fragile objects or material not resistant to the washing process.**



Note the following recommendations:

- Crockery and cutlery should not be inserted inside one another, covering each other.
- Place the crockery in order that all surfaces can be reached by water; otherwise the objects are not washed.
- Make sure all crockery are in a stable position and that the glasses don't overturn.
- Place in the rack all the glasses **upside-down**.
- Place the crockery with deep hollow with upper face downwards, so that water can flow out.
- Make sure the smaller crockery do not fall from the rack.
- Check all the wash arms runs freely and they are not blocked by too tall or too prominent crockery. Eventually, run a manual rotation of the arms to check it.

Some foods, such as carrots, tomatoes, and others, may contain some natural dyes substances, that in large amounts, can alter the crockery and plastic parts colors.

Any discoloration does not mean that the plastic is not heat resistant.

### **Crockery and cutlery not suitable for dishwasher**

Not suitable for dishwasher:

- Wooden crockery and cutlery or with wooden parts; water at high temperature causes deformation to wood. Also the adhesives used are not suitable for treatment in the dishwasher; a consequence could be the handles detachment.
- Crafts, precious vases or decorated glasses.
- Not heat-resistant plastic crockery.
- Copper, brass, pewter or aluminum objects: they may become discolored or opaque.
- The decorations on glass, after a certain number of washes, can lose gloss.
- Fragile glasses or crystal items, if often washed, can become opaque.

We recommend to buy exclusively crockery, glassware and cutlery suitable for dishwashing as poor quality items will deteriorate with frequent dishwashing.



**It is mandatory to repeat the washing cycle if at the end of the cycle the crockery are not well clean or if there are washing residues (glasses with liquid inside).**

### **Detergent use**

The machine has a standard detergent dispenser. The machine automatically sucks the detergent.

The detergent shall be the NO FOAM type, suitable for industrial dishwashers.

The use of good quality liquid detergents is recommended such as those supplied by Rhima.

Follow the manufacturer's recommendations for chemical dosage, related to the local water hardness.

A correct amount of detergent is very important for a successful wash.

Should the detergent lack, the display shows **DETERGENT LEVEL** (only with optional "Sensor for Chemicals Low Level").

A buzzer sounds at one minute intervals.

By pressing the key **Info E** the display goes back to machine ready status. The signal becomes scrolling in the display's lower part alternatively to the cycle name.

The signal remains until the detergent tank is refilled.

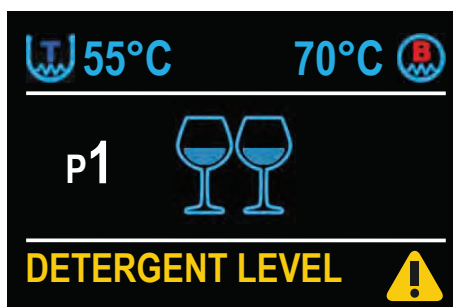

## Rinse aid use

The machine has a standard rinse aid dispenser. The machine automatically dispenses the product.

The rinse-aid chemical, shall be suitable for professional glass and dishwashers. It is advisable to rely on specialized retailers in the sector.

Should the detergent lack, the display will show **RINSE-AID LEVEL** (only with optional "Sensor for Chemicals Low Level"). A buzzer sounds at one minute intervals.

By pressing the key **Info E** the display goes back to machine ready status. The signal becomes scrolling in the display's lower part alternatively to the cycle name.

The signal remains until the detergent tank is refilled.



## Drain pump system

The machine is standardly equipped with a drain pump. It regulates the tank water level during wash cycles. At the end of the working day it drains the tank.

To proceed with a draining, both with machine ON and stand-by mode, press the key **C** until the display shows the message **TANK DRAINING**.



With the door closed, the key **Start F** is blue and flashes.

After the draining is complete, the machine will turn automatically in **STAND-BY** mode.

## Extra cold rinse function (optional)

Should the machine be equipped with a **Extra cold rinse** (optional) feature, and it is enable, after the normal rinse cycle an extra cold rinse is made for about 10 seconds with tap water.

To start the optional cycle, with machine ON, press the key **D**.

The display shows the relative symbol .

The optional cycle is active until the key **D** is pressed again. At this moment the icon disappears.





**WARNINGS:**

- Do not slam the door when opening and closing.
- Do not put material or objects on the machine.
- The machine has an IP (see serial number label on the machine) protection rating against accidental water splashes and is not protected against pressurized water jets. Pressure-cleaning systems shall, therefore, not be used on this machine.
- Do not dip bare hands into water containing detergent. If this should occur, wash them immediately with plenty of water. Check the safety instructions on the detergent container.
- Some important rules must be followed for using this appliance:
  - 1) never touch the appliance with wet hands or feet;
  - 2) never use the appliance when barefooted;
  - 3) do not install the appliance in places exposed to water splashes.
- **This machine must be disconnected from the main electrical supply after use at the end of the day and for any service/maintenance operation. Switch off the main switch located on the wall, which shall be installed by a professional installer. Shut the water supply valve(s).**
- Do not cover the intake or dissipation grids.
- Do not use water to extinguish fires on electrical parts.

**WARNING: INTERNAL CLEANING OF THE MACHINE SHALL BE CARRIED OUT AT LEAST 10 MINUTES AFTER THE POWER SWITCH HAS BEEN TURNED OFF.**

**WARNING: DO NOT INSERT HANDS AND/OR TOUCH THE PARTS LOCATED AT THE BOTTOM OF THE WASH TANK AND/OR AT THE END OF THE WASH CYCLE.**



## DAILY MAINTENANCE

**WARNING:** The machine is not protected against pressurized water jets. Do not use pressure cleaning system against the machine.

It is recommended to contact the seller of chemicals for proper cleaning instructions, in order to have detailed indications on methods and products for the correct periodical machine sanitation.

**Do not use bleach or chlorine based detergents.**

Daily cleaning is needed to ensure that the machine runs perfectly. The following shall be carried out:

- Turn the machine in **STAND-BY** mode, by pressing the button **A**.
- Remove the surface filters and clean them under running water. Drain the sump water.
- Remove the pump filter and clean with a brush and a water shower (see pict. 4).
- Remove the arms by loosening the fixing screws, and thoroughly clean them, and the wash and rinse holes under running water (see pict. 5).
- Reassemble the parts and reposition the wash pipes firmly in place.

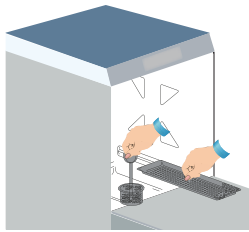

pict. 4

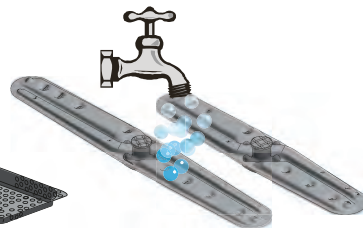
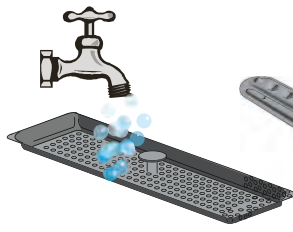

pict. 5

- Clean the tank very carefully, using a water shower.
- It is suggested to leave the door of the machine open at the end of the day.

**Automatic cycle of machine self-cleaning/rinsing:** recommended at each day end.

Machine in **STAND-BY** mode, the scrolling message **SELF-CLEANING: REMOVE FILTERS AND PRESS START** appears on the lower part of the display.

Remove the filters.

Shut the door.



Push the button **Start F**. An automatic cycle of about 1 minute will start, after this the machine will be in **STAND-BY**. The message **SELF-CLEANING CYCLE OVER** appears.

- Shut the water valve.
- Turned the machine off by switching the main power switch OFF.

**Note:** This operation allows the complete draining of the boiler, in order to remove any air bubbles, which may cause malfunctions.

### Extraordinary Maintenance – by qualified Service Personnel only



Once or twice per year, the machine should be checked by qualified Service Personnel:

- 1 Clean the intake filter of the solenoid valve
- 2 Remove scaling from the heating elements
- 3 Check the status and the tightness of all gaskets
- 4 Check the perfect state and/or wear of the components
- 5 Check the efficiency of the dispensers
- 6 Tighten firmly all electrical connections.



## ECOLOGICAL ASPECTS

### Recommendations for optimal use of energy, water and additives

Use the machine fully loaded when possible: This shall prevent detergent, rinse aid, water and energy consumption waste.

Detergent and rinse-aids: Use detergents and rinse-aid chemicals with high biodegradability, to best respect the environment. Verify proper dosage in relation to water hardness at least three times a year. Excess product pollutes rivers and seas while an insufficient dose results in unsatisfactory objects washing and/or hygiene.

Boiler and Wash-Tank temperatures: The boiler and tank temperatures are set by the manufacturer in order to obtain the best washing results with detergents on the market. The temperatures can be reset by the installer in relation to your detergent.

Pre-washing: Carefully pre-wash with a moderate amount of water at room temperature to facilitate the removal of animal fats. To remove encrusted materials warm water soaking is recommended.

Note: Wash objects as soon as possible to avoid deposits from drying and compromise effective washing. For effective washing routine dishwasher cleaning and maintenance is advised.

**Disregarding the points listed above and of any the information contained in this manual can cause energy, water and detergent waste with a subsequent increase in running costs and/or performance reduction.**

### H.A.C.C.P. AND HYGIENE REGULATIONS

- When starting the machine ON, no wash-cycle will be starting until the set boiler and wash-tank temperatures are reached. During operation, the machine will not start the rinse cycle till the set boiler temperature is reached.
- Remove carefully all solids from the objects to be washed, to avoid obstruction of filters, nozzles and piping.
- Drain the wash tank and clean the filters at least twice a day.
- Check if the detergent and rinse-aid dosage are correct (as recommended by the manufacturer). In the morning, before starting the machine, check that the quantity of chemicals in the canisters is enough for daily supply.
- Keep your working tables clean.
- Extract the rack with clean hands or gloves to avoid finger marks.
- Do not dry or polish the washed objects with cloths, brushes or rags that are not sterile.



Australia

Tel: 1300 347 944

New Zealand

Tel: 0800 902 054

Singapore

Tel: +65 9107 8943

## DETERGENTS

To request detergents or rinse additive contact your local Rhima Service centre below:

Australia: **1300 347 944**  
New Zealand: **0800 902 054**  
Singapore: **+65 9107 8943**



### Mediwash

5 Litre

For washing glass & instrument washing



### Final rinse

5 Litre



### Superwash

5 Litre

For all other washing

